

Agilent 86122A
Multi-Wavelength Meter
User's Guide



Notices

© Agilent Technologies, Inc. 2002-2004
This document contains proprietary information that is protected by copyright. All rights are reserved.

No part of this document may reproduced in (including electronic storage and retrieval or translation into a foreign language) without prior agreement and written consent from Agilent Technologies GmbH as governed by United States and international copyright laws.

Agilent Technologies Deutschland GmbH
Herrenberger Str. 130
71034 Böblingen
Germany

Manual Part Number

86122-90004

Edition

Second edition, November 2004

First edition, July 2003

Warranty

This Agilent Technologies instrument product is warranted against defects in material and workmanship for a period of one year from date of shipment. During the warranty period, Agilent will, at its option, either repair or replace products that prove to be defective.

For warranty service or repair, this product must be returned to a service facility designated by Agilent. Buyer shall prepay shipping charges to Agilent and Agilent shall pay shipping charges to return the product to Buyer. However, Buyer shall pay all shipping charges, duties, and taxes for products returned to Agilent from another country.

Agilent warrants that its software and firmware designated by Agilent for use with an instrument will execute its programming instructions when properly installed on that instrument. Agilent does not warrant that the

operation of the instrument, software, or firmware will be uninterrupted or error free.

Limitation of Warranty

The foregoing warranty shall not apply to defects resulting from improper or inadequate maintenance by Buyer, Buyer-supplied software or interfacing, unauthorized modification or misuse, operation outside of the environmental specifications for the product, or improper site preparation or maintenance.

No other warranty is expressed or implied. Agilent Technologies specifically disclaims the implied warranties of Merchantability and Fitness for a Particular Purpose.

Exclusive Remedies

The remedies provided herein are Buyer's sole and exclusive remedies. Agilent Technologies shall not be liable for any direct, indirect, special, incidental, or consequential damages whether based on contract, tort, or any other legal theory.

Assistance

Product maintenance agreements and other customer assistance agreements are available for Agilent Technologies products. For any assistance contact your nearest Agilent Technologies Sales and Service Office.

Certification

Agilent Technologies Inc. certifies that this product met its published specifications at the time of shipment from the factory.

Agilent Technologies further certifies that its calibration measurements are traceable to the United States National Institute of Standards and Technology,

NIST (formerly the United States National Bureau of Standards, NBS) to the extent allowed by the Institutes's calibration facility, and to the calibration facilities of other International Standards Organization members.

ISO 9001 Certification

Produced to ISO 9001 international quality system standard as part of our objective of continually increasing customer satisfaction through improved process control.

Safety Notices

CAUTION

A CAUTION notice denotes a hazard. It calls attention to an operating procedure, practice, or the like that, if not correctly performed or adhered to, could result in damage to the product or loss of important data. Do not proceed beyond a CAUTION notice until the indicated conditions are fully understood and met.

WARNING

A WARNING notice denotes a hazard. It calls attention to an operating procedure, practice, or the like that, if not correctly performed or adhered to, could result in personal injury or death. Do not proceed beyond a WARNING notice until the indicated conditions are fully understood and met.

Warnings and Notices

WARNING

To avoid the possibility of injury or death, you must observe the following precautions before switching on the instrument.

Insert the power cable plug only into a socket outlet provided with a protective earth contact. Do not negate this protective action by the using an extension cord without a protective conductor.

WARNING

Never look directly into the end of a fiber or a connector, unless you are absolutely certain that there is no signal in the fiber.

Agilent Technologies Sales and Service Offices

For more information about Agilent Technologies test and measurement products, applications, services, and for a current sales office listing, visit our web site:

<http://www.agilent.com/comms/lightwave>

You can also contact one of the following centers and ask for a test and measurement sales representative.

United States:	1 800 829 4444 1 800 829 4433(FAX)
Canada:	1 877 894 4414 (1888 900 8921(FAX))
Europe:	(31 20) 547 2111 (31 20) 547 2190 (FAX)
Japan:	0120 421 345 0120 421 678 (FAX)
Mexico	(52 55) 5081 9469 (52 55) 5081 9467 (FAX)
Australia:	1 800 629 485 1 800 142 134 (FAX)
Asia-Pacific:	800 930 871 800 908 476 (FAX)
Brazil	(55 11) 4197 3600 (55 11) 4197 3800 (FAX)

Contents

Setting Up the 86122A	9
General Safety Considerations	10
Step 1. Inspect the Shipment	15
Options and Accessories	16
Step 2. Consider Environmental Specifications	18
Step 3. Configure for Bench Top or Rack Mount Use	20
Step 4. Connect a Keyboard and Mouse (Optional)	22
Step 5. Connect the Line Cord	23
Line Power Cable	24
Step 6. Turn On the Line Power	25
Interacting With the Display	26
Step 7. Calibrate the Touch Screen (Optional)	27
Step 8. Set the Time and Date	29
Step 9. Set the System Standby Mode	30
Step 10. Add a Printer	32
Step 11. Avoid costly repairs	36
Step 12. For More Information	37
Cleaning Connections for Accurate Measurements	38
Choosing the Right Connector	38
Inspecting Connectors	41
Cleaning Connectors	45
Returning the Instrument for Service	49
Preparing the instrument for shipping	50
Agilent Technologies Service Offices	52
Call Center	52
Service Center	52
Hard Drive Backup and Recovery	53
Create a New System Utility Disk	54
Working in Comfort	55
About Repetitive Strain Injury	56
Mice and Other Input Devices	58

Using the 86122A	59
<hr/>	
Introduction	60
Differences Between the 86122A and the 86120C	61
Differences in General Operation	62
Differences in Remote Commands	63
Front and Rear Panel Features	64
Rear Panel	64
Front Panel	65
Main Screen Layout	66
Graphs and Tables	68
Front Panel Buttons	69
Menus	71
86122A Dialog Box Operation	75
Making Measurements	76
Step 1. Consider Measurement Limitations	76
Step 2. Select Basic Measurement Setup Parameters	78
Step 3. Define Laser-Line Peaks	81
Step 4. Make Measurements	83
Step 5. Adjust the Graph to Your Preference	86
Step 6. Save Measurement Results	89
Using the Built-In Information System	93
<hr/>	
Introduction	94
The 86122A Help Contents	95
Description of the Contents Topics	96
Getting Help While Changing Instrument Settings	98
Hiding the Help	99
Printing the Contents of a Topic	100
Selecting the Help Language	101
Specifications and Regulatory Information	103
<hr/>	
Specifications	104
Laser Safety Information	107



Compliance with German Noise Requirements	108
Compliance with Canadian EMC Requirements	108
Declaration of Conformity	109



1

Setting Up the 86122A

General Safety Considerations.....	10
Step 1. Inspect the Shipment	15
Step 2. Consider Environmental Specifications	18
Step 3. Configure for Bench Top or Rack Mount Use	20
Step 4. Connect a Keyboard and Mouse (Optional).....	22
Step 5. Connect the Line Cord	23
Step 6. Turn On the Line Power	25
Step 7. Calibrate the Touch Screen (Optional)	27
Step 8. Set the Time and Date	29
Step 9. Set the System Standby Mode	30
Step 10. Add a Printer	32
Step 11. Avoid costly repairs.....	36
Step 12. For More Information	37
Cleaning Connections for Accurate Measurements	38
Returning the Instrument for Service	49
Agilent Technologies Service Offices	52
Hard Drive Backup and Recovery	53

This chapter shows you how to properly set up your 86122A. Follow the setup steps in the order presented. In addition, you will learn how to use proper optical connection cleaning techniques to avoid *costly* repairs. Lastly, this chapter explains how to return your instrument for service.

General Safety Considerations

This product has been designed and tested in accordance with the standards listed in the Manufacturer's Declaration of Conformity, and has been supplied in a safe condition. The documentation contains information and warnings which must be followed by the user to ensure safe operation and to maintain the product in a safe condition.

Safety Symbols









CAUTION

The *caution* sign denotes a hazard. It calls attention to a procedure which, if not correctly performed or adhered to, could result in damage to or destruction of the product. Do not proceed beyond a caution sign until the indicated conditions are fully understood and met.

WARNING

The *warning* sign denotes a hazard. It calls attention to a procedure which, if not correctly performed or adhered to, could result in injury or loss of life. Do not proceed beyond a warning sign until the indicated conditions are fully understood and met.

Instrument Markings

-  The instruction manual symbol. The product is marked with this warning symbol when it is necessary for the user to refer to the instructions in the manual.
-  The laser radiation symbol. This warning symbol is marked on products which have a laser output.
-  The AC symbol is used to indicate the required nature of the line module input power.
-  The ON symbols are used to mark the positions of the instrument power line switch.
-  The OFF symbols are used to mark the positions of the instrument power line switch.
-  The CE mark is a registered trademark of the European Community.
-  The CSA mark is a registered trademark of the Canadian Standards Association.
-  The C-Tick mark is a registered trademark of the Australian Spectrum Management Agency.
- ISM1-A This text denotes the instrument is an Industrial Scientific and Medical Group 1 Class A product.

WARNING

If this product is not used as specified, the protection provided by the equipment could be impaired. This product must be used in a normal condition (in which all means for protection are intact) only.

WARNING

No operator serviceable parts inside. Refer servicing to qualified service personnel. To prevent electrical shock do not remove covers.

WARNING

This is a Safety Class 1 Product (provided with protective earth). The mains plug shall only be inserted in a socket outlet provided with a protective earth contact. Any interruption of the protective conductor inside or outside of the instrument is likely to make the instrument dangerous. Intentional interruption is prohibited.

WARNING

To prevent electrical shock, disconnect the instrument from mains before cleaning. Use a dry cloth or one slightly dampened with water to clean the external case parts. Do not attempt to clean internally.

CAUTION

This product complies with Overvoltage Category II and Pollution Degree 2.

CAUTION

Always use the three-prong AC power cord supplied with this instrument. Failure to ensure adequate earth grounding by not using this cord may cause instrument damage.

CAUTION

This instrument has autoranging line voltage input. Be sure the supply voltage is within the specified range.

CAUTION

Use of controls or adjustment or performance of procedures other than those specified herein may result in hazardous radiation exposure.

CAUTION

The 86122A Multi-Wavelength Meter uses a specially designed Windows 98 application program (Windows® is a U.S. registered trademark of Microsoft Corp.) All 86122A Multi-Wavelength Meter functionality is directly available from within the 86122A Multi-Wavelength Meter application. Windows 98 configuration changes made outside of the 86122A Multi-Wavelength Meter application may not work correctly and could cause the instrument to become inoperable. Do not try to access or make changes to the Windows Operating system. Repairs caused by the improper use of the 86122A Multi-Wavelength Meter will not be covered under warranty.

CAUTION

VENTILATION REQUIREMENTS: When installing the product in a cabinet, the convection into and out of the product must not be restricted. The ambient temperature (outside the cabinet) must be less than the maximum operating temperature of the product by 4° C for every 100 watts dissipated in the cabinet. If the total power dissipated in the cabinet is greater than 800 watts, then forced convection must be used.

CAUTION

Install the instrument so that the detachable power cord is readily identifiable and is easily reached by the operator. The detachable power cord is the instrument disconnecting device. It disconnects the mains circuit from the mains supply before other parts of the instrument. The front panel switch is only a standby switch and is not a LINE switch. Alternatively, an externally installed switch or circuit breaker (which is readily identifiable and is easily reached by the operator) may be used as a disconnecting device.

Laser Safety Considerations

NOTE

Refer to the *Tunable Laser Modules User's Guide* for complete laser safety information.

WARNING

Do NOT, under any circumstances, look into the optical output or any fiber/device attached to the TLS output while the laser is in operation.

This system should be serviced only by authorized personnel.

Do not enable the laser unless fiber or an equivalent device is attached to the optical output connector.

CAUTION

Use of controls or adjustments or performance of procedures other than those specified herein can result in hazardous radiation exposure.

Step 1. Inspect the Shipment

1 Use proper lifting techniques to remove the items from the shipping container.

NOTE

Keep the shipping container and cushioning material until you have inspected the contents of the shipment for completeness and have inspected the instrument.

2 Inspect the shipment.

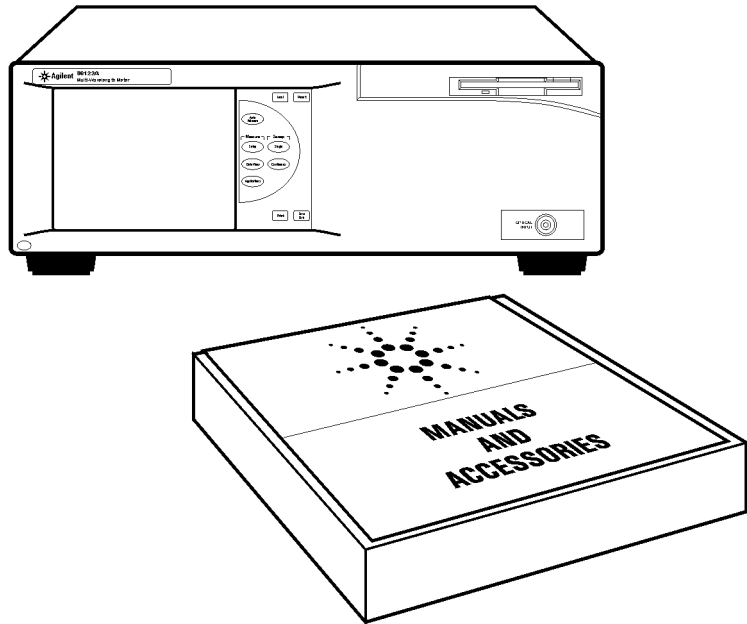

- Inspect the shipping container for damage.
- Inspect the instrument.
- Verify that you received the options and accessories you ordered.

If anything is missing or defective, contact your nearest Agilent Technologies Service Office. [Refer to “Agilent Technologies Service Offices” on page 52.](#) If the shipment was damaged, contact the carrier, then contact the nearest Agilent Sales Office. Keep the shipping materials for the carrier’s inspection. The Agilent Sales Office will arrange for repair or replacement at Agilent’s option without waiting for claim settlement.

Options and Accessories

The following table lists the accessories that may be on the 86122A shipping list. The information on your actual shipping list is more accurate and should supersede the information in this table.

Table 1 Standard Accessories





Accessory	Part Number
Stylus	1535-5213
Recovery Disk	5011-1306
Getting Started (this book)	86122-90001
Power Cord	depends on country
FC/PC Connector	08154-61702

The following table lists the available product options. Make sure that you received all of the options that you ordered.

Table 2 Instrument Options

Option	Description
Optical Connectors	
86122A-021	Straight (non-angled) Contact Interface-PC (default)
86122A-022	Angled Contact Interface-APC
86122A-400	Front Panel Fiber Input (default)
86122A-401	Rear Panel Fiber Input
Accessories	
86122A-1CM	Rack Mount Kit without Handles
86122A-1CN	Handle Kit
86122A-1CP	Rack Mount Kit plus Handles
86122A-UK6	Commercial Calibration Certificate with Test Data
Documentation	
86122A-ABA	English Getting Started (default)

Table 3 Fiber-Optic Adapters

Front Panel Fiber-Optic Adapter	Description	Agilent Part Number
	FC/PC	81000FI
	SC	81000KI
	DIN	81000SI
	ST	81000VI

Step 2. Consider Environmental Specifications

Review the following specifications to ensure that your operating or storage environment is suitable for the instrument

Temperature	
Operating	0°C to +55°C +15°C to +35°C for Option 002
Non-operating	-40°C to +70°C
Humidity	
Operating	< 75% relative humidity at +35°C, 5 day soak < 95% relative humidity at +40°C, 5 day soak for Option 001
Non-operating	Noncondensing 95% relative humidity at +40°C for 5 day cycle
Altitude	
Operating	Up to 2000m (6600 ft)

NOTE

Humidity is type tested. Type tested means tested, but not warranted, for continuous operation.

Shock 120 g, half sine, 2 ms pulse

NOTE

Shock is type tested.

Vibration Random, 2 g rms, 5-500 Hz, 10 minutes per axis
Sine, 0.5 g (0 to peak), 5 to 500 Hz, 1 octave per minute

NOTE

Vibration is type tested.

Power Requirements	
Voltage	100-240 V~
Frequency	50-60 Hz
Maximum Power	150 W
Weight	14.5 kg (32 lb)
Dimensions	
Height	138 mm (5.2 in)
Width	425 mm (16.7 in)
Depth	520 mm (20.5 in)

Step 3. Configure for Bench Top or Rack Mount Use

The 86122A is shipped ready for bench top use. To configure the instrument for rack mount use, follow the steps below.

NOTE

You must have a rack mount kit to continue with this procedure. Refer to "Accessories" on page 16.

1 Ensure that the rack mount kit is complete.

If any items are damaged or missing from the kit, contact the nearest Agilent Technologies sales or service office to order a replacement kit. Items within the kit are not individually available.

Table 4

Qty	Description
2	Rack Mount Flange
6	Screws
4	Dress screws
2	Front Handle Assembly (86122A-1CP only)

2 Remove the side trim strips.

3 Attach rack mount flange with three screws per side.

WARNING

Use only the screws the come with the rack mount kit. Longer screws may damage the instrument, and shorter screws may be unsafe.

4 Remove feet before rack mounting

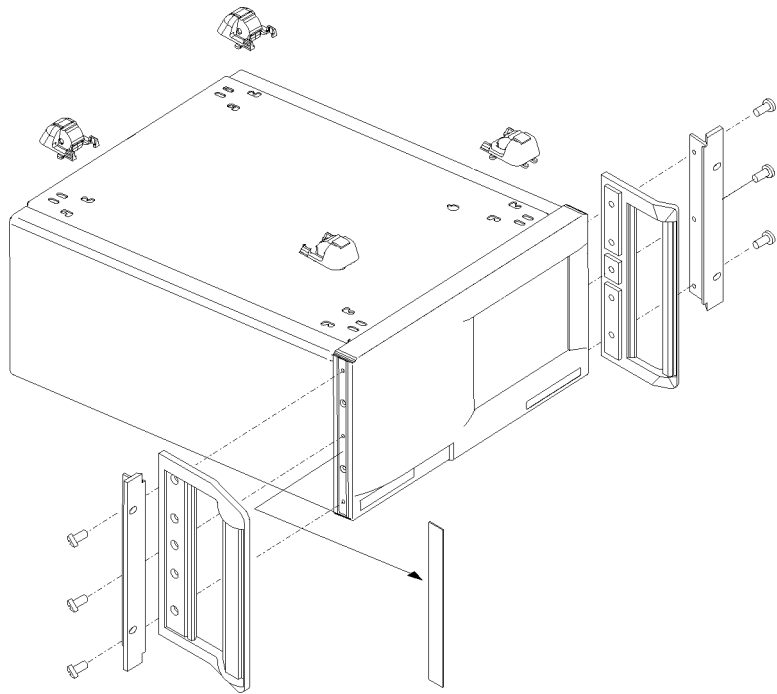

Front Handle Assembly are included with Option 86122A-1CP only.

Step 4. Connect a Keyboard and Mouse (Optional)

You may connect a standard PC-compatible mouse and keyboard to the instrument. Refer to the figure below for PS/2 connections. You can also use the USB port for a USB keyboard and mouse.

NOTE

A keyboard and mouse are not supplied with the 86122A.

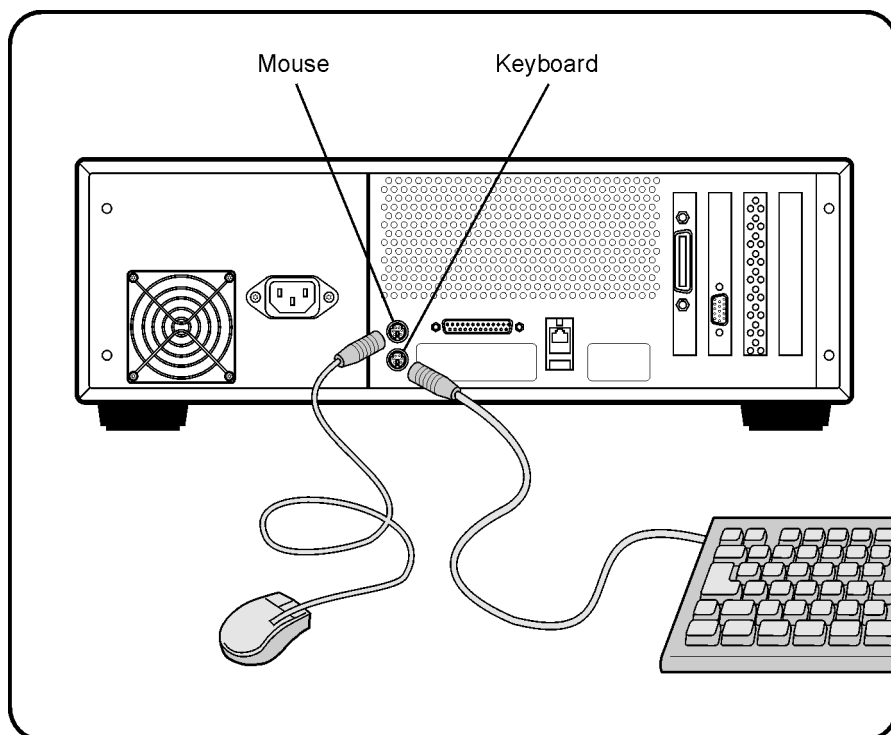
**NOTE**

Do *not* stack other objects on the keyboard; this will cause self-test failures at power-on.

Step 5. Connect the Line Cord

Connect the line cord as shown in the figure below.

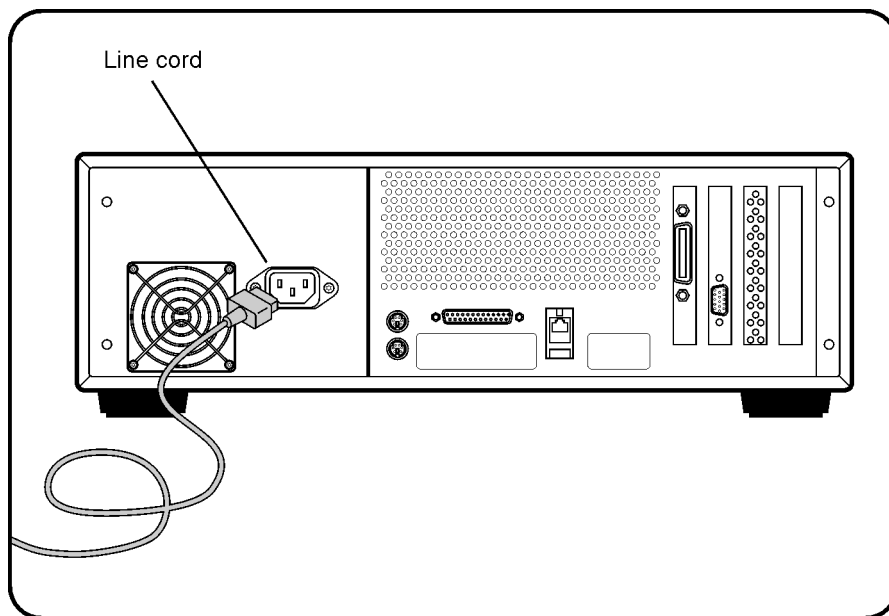

The Agilent Variable Optical Attenuator modules and Agilent Variable Optical Attenuator modules with Power Control automatically adjusts for line input voltages in the range of 115 to 240 V~. There is no manual selection switch.

The line cord provided is matched by Agilent to the country in which the order originates.

CAUTION

This instrument has autoranging line voltage input. Be sure the supply voltage is within the specified range.

Table 5 Line Power Requirements

Voltage	110-240 V~
Frequency	50-60 Hz
Maximum Power	150 W

Line Power Cable

According to international safety standards, this instrument has a three-wire power cable. When connected to an appropriate AC power receptacle, this cable earths the instrument cabinet. The type of power cable shipped with each instrument depends on the country of destination.

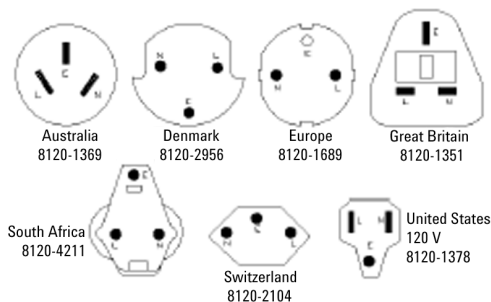

Line Power Cables - Plug Identification

Step 6. Turn On the Line Power

Press the power switch at the lower left-hand corner of the front panel. After at least one minute, the display will look similar to the following figure.

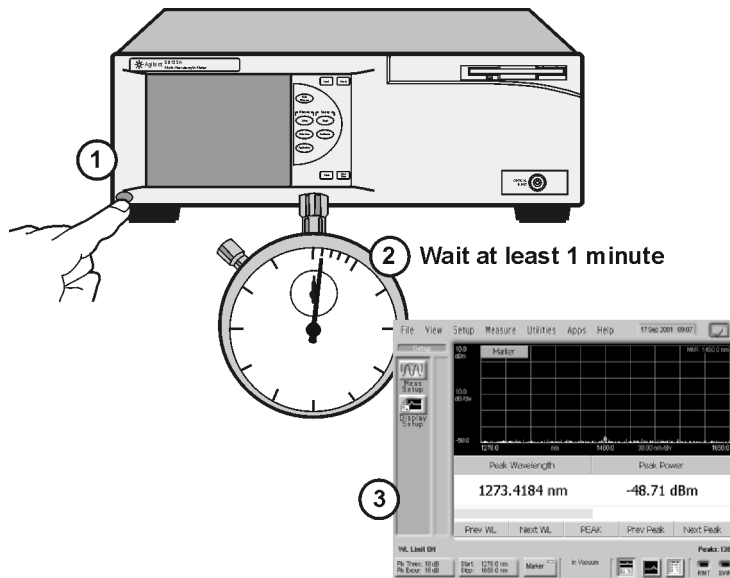

The Agilent Variable Optical Attenuator modules and Agilent Variable Optical Attenuator modules with Power Control is ready to use!

Interacting With the Display

The 86122A is equipped with a touch screen display. You can explore the instrument's functions and settings by touching elements on the display (such as menus, buttons, and other controls) with your finger or the supplied stylus.

You can also operate the instrument by using an optional mouse. For simplicity, the term "click" is used throughout this book to represent *clicking or touching* an element on the display. When you see the term "click," please remember that you can always touch with your finger or stylus instead.

NOTE

The display will always function as a touch screen, even when a mouse and keyboard are connected.

CAUTION

Avoid touching the screen with a sharp object, as this could result in damage to the display. Use your finger or the supplied stylus.

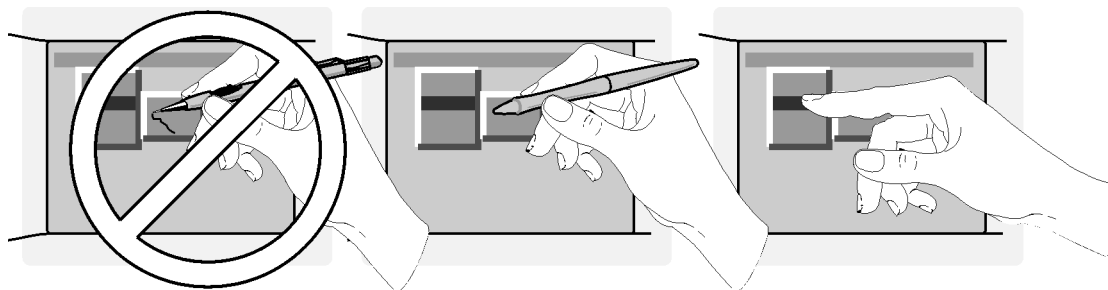

Step 7. Calibrate the Touch Screen (Optional)

NOTE

The touch screen calibration rarely needs to be performed.

Touch screen calibration ensures that the touch screen is both accurately aligned and orientated with the display. Therefore, when you touch an element on the display screen, the instrument can detect the task you want to perform.

- 1 On the Utility menu, click Touch Screen Calibration. The touch screen calibration utility opens.

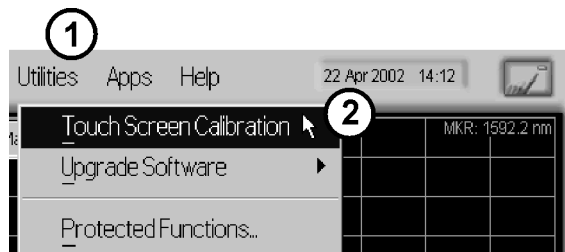

- 2 Touch the center of the X with your finger or a stylus. The X will move to the opposite corner of the display screen. When the display is calibrated, the touch screen configuration utility closes.

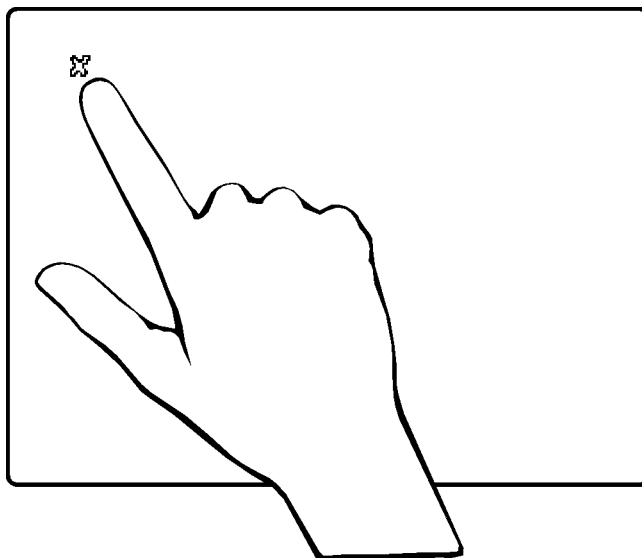

The calibration will time out within 10 seconds if you do not touch the center of the X. You can also press Esc on an optional keyboard to exit the touch screen calibration.

NOTE

If you miss the center of the X by a significant amount, the instrument will display an error message and revert back to the previous calibration. This will prevent the touch screen from being rendered useless due to a poor calibration.

Step 8. Set the Time and Date

- 1 Click the current time and date shown near the top of the display. The Set Time and Date dialog box opens.
- 2 Enter the current time and date in one of the following ways:
 - Click the time and date text boxes, and enter the desired number.
 - Click the up or down arrows next to the time and date text boxes until the desired number is displayed.
- 3 Click **Set Time & Date Now** to apply the changes and close the dialog box.

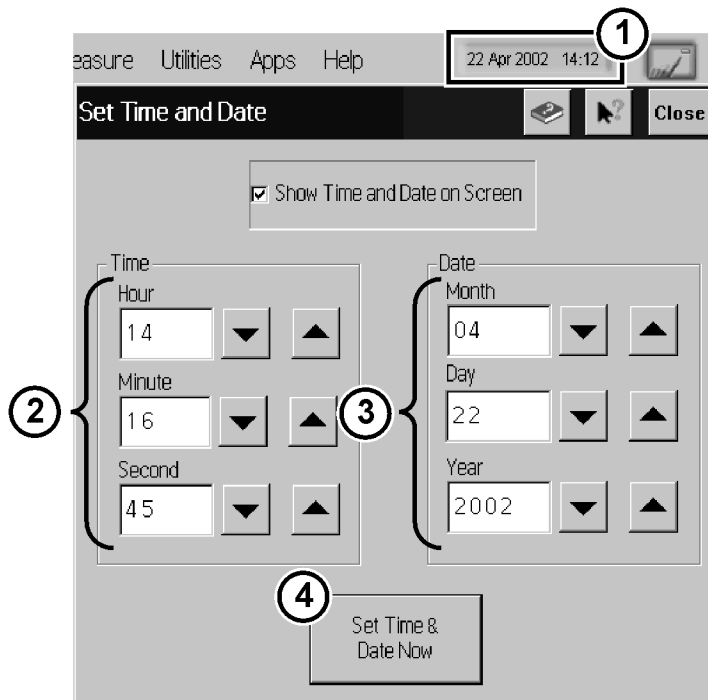

Step 9. Set the System Standby Mode

If the multi-wavelength meter has been inactive for a specified period of time, it will be switched into standby mode. When this happens, two things will occur:

- The LCD display will be turned off.
- If the instrument is in Continuous sweep mode, the motor movement, and any related data collection, will be suspended.

NOTE

The internal reference laser is always on to allow the instrument to immediately make accurate measurements when it is reactivated.

Any subsequent activity, front-panel or remote, will reactivate the instrument and return it to its previous state. Using this feature can help extend the life of your instrument. To extend the life of the reference laser, you should turn off the instrument during long periods of inactivity.

To configure standby mode

- 1 On the Setup menu, click Preferences.
- 2 Select a time-out period from the System Standby list. You can choose 15 min., 30 min., 1 hr., 4 hrs., or Never. Selecting **Never** disables this feature.

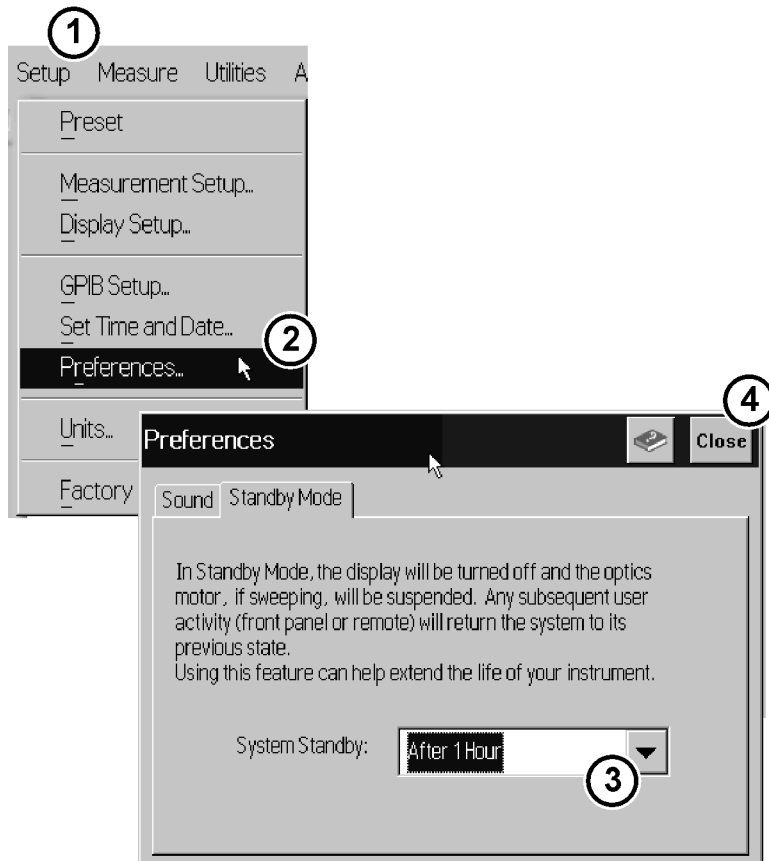

To reactivate the display

- Touch the display screen or a front panel button
- Move the mouse or press a key on the external keyboard (if attached)
- Send a remote command

Step 10. Add a Printer

Use of a printer with the 86122A is optional. Follow the steps below to add a printer.

NOTE

The 86122A only supports parallel printers. USB printers cannot be used.

- 1 Turn off the instrument and connect your printer to rear-panel parallel port as shown below.

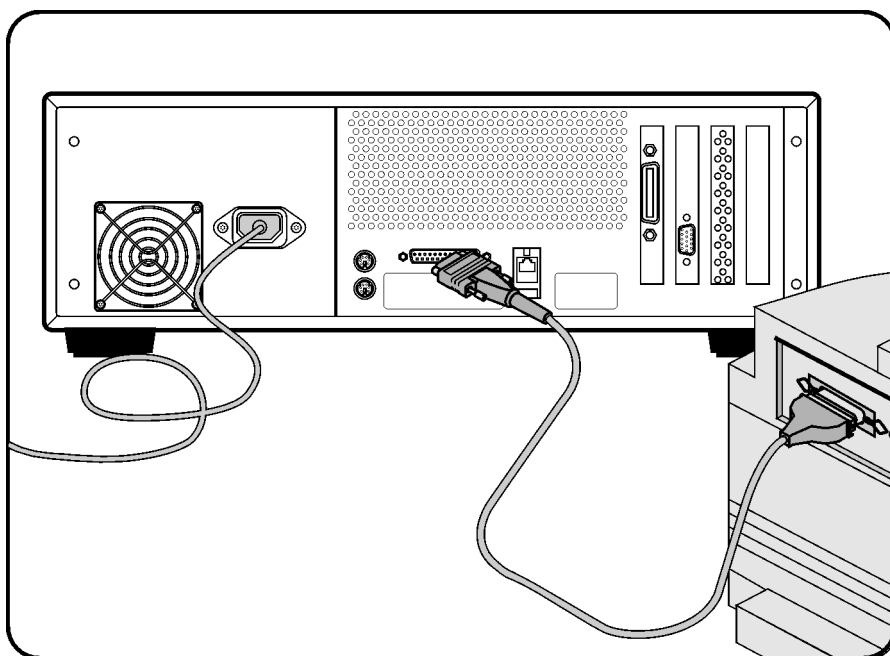

- 2 Turn on the instrument.

3 Exit the 86122A software

- a** On the Utilities menu, click Protected Functions.
- b** Enter the protected functions password “exit to windows” and click Activate.

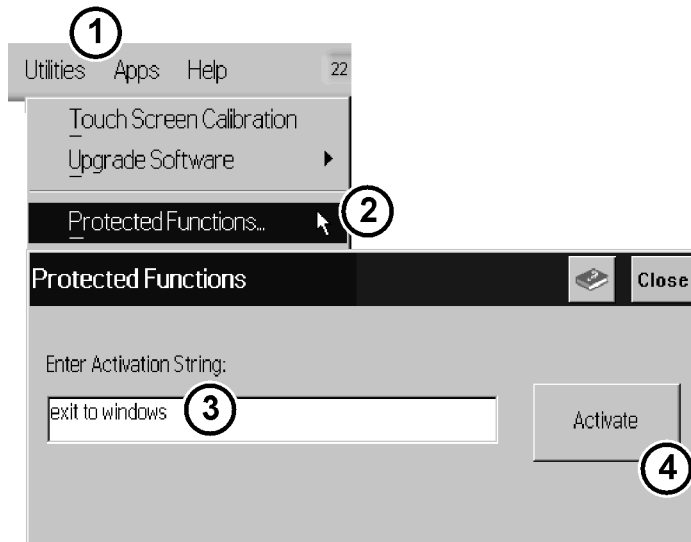
**NOTE**

If your printer includes an executable file, please run the setup.exe. You can then disregard the rest of this procedure.

CAUTION

Installation of programs other than drivers necessary for your printer is not recommended or supported. Installation of additional software could render the 86122A software inoperable.

4 On the Start menu, point to Settings, and then click Printers.

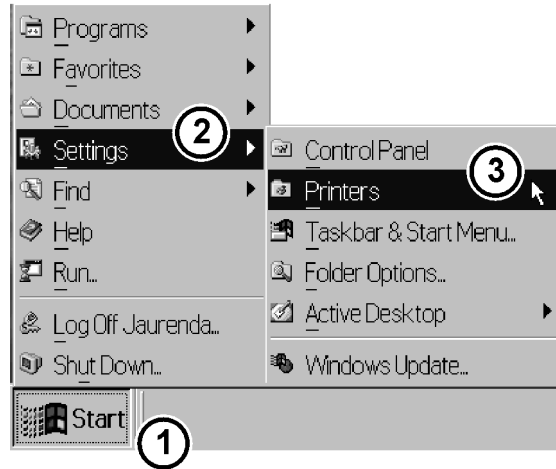

5 Double-click Add Printer. The Add Printer Wizard opens. Click Next.

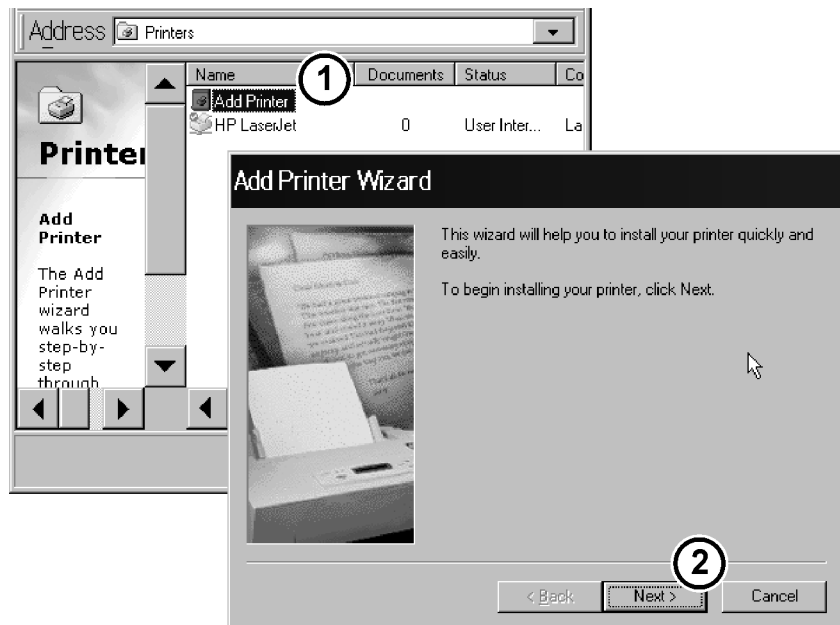

6 Click Local printer, then click Next. The Add Printer Wizard displays a list of printer models and manufacturers.

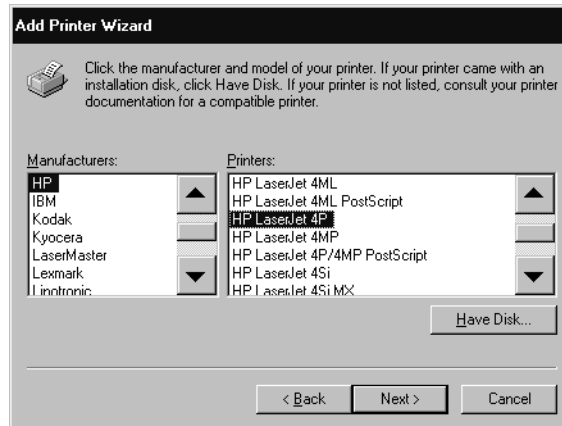

7 You can select the manufacturer and model of your printer from the list and load the printer driver.

Or,

If you have one of the following printers, click Have Disk. The Install from Disk dialog box opens.

- HP Deskjet 990c series
- HP Deskjet 970c series
- HP Deskjet 950c series
- HP Deskjet 940c series
- HP Deskjet 930c series

The drivers for the above printers are pre installed for your convenience. In the text box of the Install from Disk dialog box, type the following path:

c:\ossetup\PrinterDrivers

Or,

If your printer includes an .inf file, click Have Disk. You can then type the path where the .inf file resides.

8 To return to the 86122A software, cycle the instrument power, or click Start, point to Programs, and then click 86122A.

Step 11. Avoid costly repairs

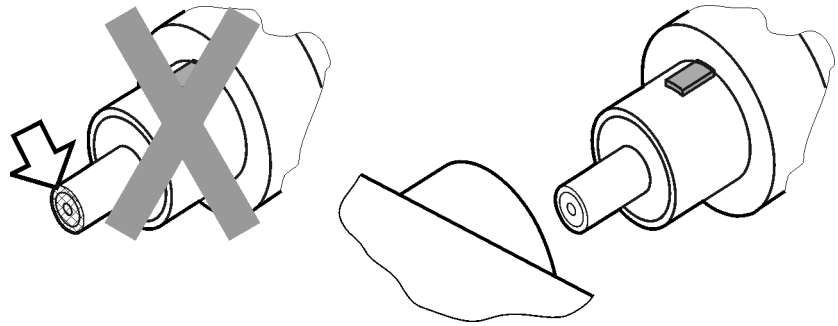
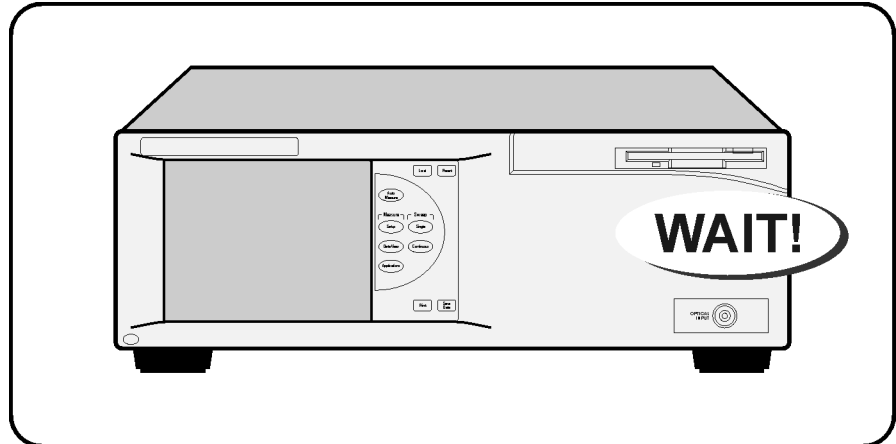

CAUTION

Optical channel fiber-optic connectors are easily damaged when connected to dirty or damaged cables and accessories. When you use improper cleaning and handling techniques, you risk expensive instrument repairs, damaged cables, and compromised measurements. Before you connect any fiber-optic cable to the Agilent Variable Optical Attenuator modules and Agilent Variable Optical Attenuator modules with Power Control, refer to [“Cleaning Connections for Accurate Measurements”](#) on page 38.

Step 12. For More Information

There are several ways to learn more about your 86122A.

- Continue reading this book. Chapter 3, "Using the 86122A," will help you get started using this instrument.
- Refer to the Help. The Help contains the information that would normally be in the user's and programmer's guide.

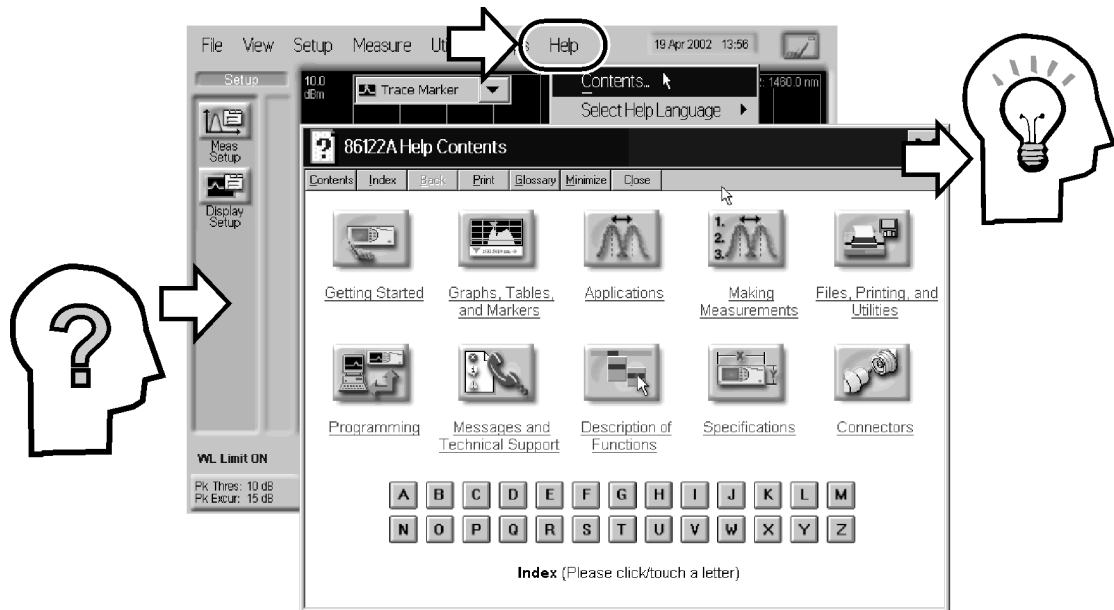

- Visit our website at <http://www.agilent.com>. Use the keyword "86122A" in your search.

Search: in

Cleaning Connections for Accurate Measurements

Today, advances in measurement capabilities make connectors and connection techniques more important than ever. Damage to the connectors on calibration and verification devices, test ports, cables, and other devices can degrade measurement accuracy and damage instruments. Replacing a damaged connector can cost thousands of dollars, not to mention lost time! This expense can be avoided by observing the simple precautions presented in this book. This book also contains a brief list of tips for caring for electrical connectors.

Choosing the Right Connector

A critical but often overlooked factor in making a good lightwave measurement is the selection of the fiber-optic connector. The differences in connector types are mainly in the mechanical assembly that holds the ferrule in position against another identical ferrule. Connectors also vary in the polish, curve, and concentricity of the core within the cladding. Mating one style of cable to another requires an adapter. Agilent Technologies offers adapters for most instruments to allow testing with many different cables. [Figure 1 on page 39](#) shows the basic components of a typical connector.

The system tolerance for reflection and insertion loss must be known when selecting a connector from the wide variety of currently available connectors. Some items to consider when selecting a connector are:

- How much insertion loss can be allowed?
- Will the connector need to make multiple connections? Some connectors are better than others, and some are very poor for making repeated connections.
- What is the reflection tolerance? Can the system take reflection degradation?
- Is an instrument-grade connector with a precision core alignment required?
- Is repeatability tolerance for reflection and loss important? Do your specifications take repeatability uncertainty into account?
- Will a connector degrade the return loss too much, or will a fusion splice be required? For example, many DFB lasers cannot operate with reflections from connectors. Often as much as 90 dB isolation is needed.

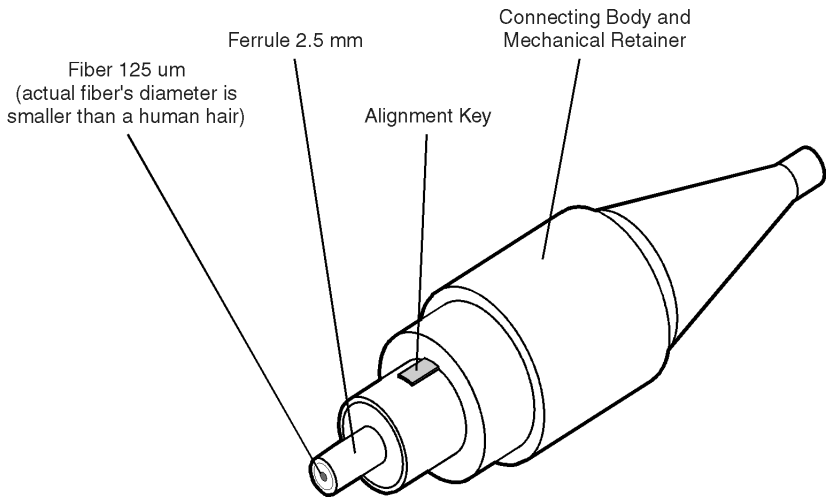

Figure 1 Basic components of a connector.

Over the last few years, the FC/PC style connector has emerged as the most popular connector for fiber-optic applications. While not the highest performing connector, it represents a good compromise between performance, reliability, and cost. If properly maintained and cleaned, this connector can withstand many repeated connections.

However, many instrument specifications require tighter tolerances than most connectors, including the FC/PC style, can deliver. These instruments cannot tolerate connectors with the large non-concentricities of the fiber common with ceramic style ferrules. When tighter alignment is required, Agilent Technologies instruments typically use a connector such as the Diamond HMS-10, which has concentric tolerances within a few tenths of a micron. Agilent Technologies then uses a special universal adapter, which allows other cable types to mate with this precision connector. See [Figure 2](#).



Figure 2 Universal adapters to Diamond HMS-10.

The HMS-10 encases the fiber within a soft nickel silver (Cu/Ni/Zn) center which is surrounded by a tough tungsten carbide casing, as shown in [Figure 3](#).

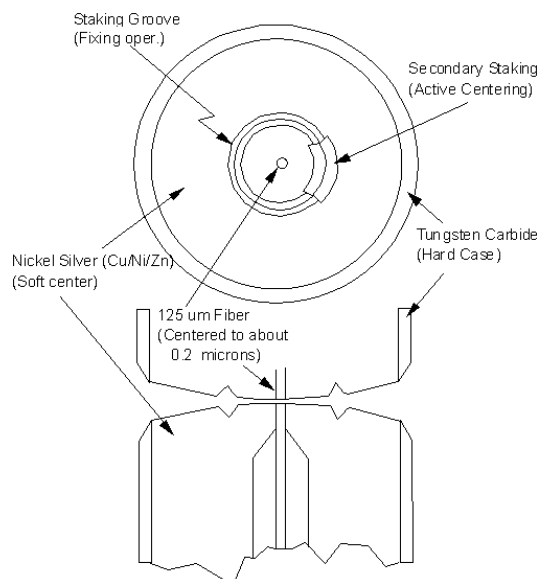

Figure 3 Cross-section of the Diamond HMS-10 connector.

The nickel silver allows an active centering process that permits the glass fiber to be moved to the desired position. This process first stakes the soft nickel silver to fix the fiber in a near-center location, then uses a post-active staking to shift the fiber into the desired position within $0.2 \mu\text{m}$. This process, plus the keyed axis, allows very precise core-to-core alignments. This connector is found on most Agilent Technologies optical instruments.

The soft core, while allowing precise centering, is also the chief liability of the connector. The soft material is easily damaged. Care must be taken to minimize excessive scratching and wear. While minor wear is not a problem if the glass face is not affected, scratches or grit can cause the glass fiber to move out of alignment. Also, if unkeyed connectors are used, the nickel silver can be pushed onto the glass surface. Scratches, fiber movement, or glass contamination will cause loss of signal and increased reflections, resulting in poor return loss.

Inspecting Connectors

WARNING

Always remove both ends of fiber-optic cables from any instrument, system, or device before visually inspecting the fiber ends. Disable all optical sources before disconnecting fiber-optic cables. Failure to do so may result in permanent injury to your eyes.

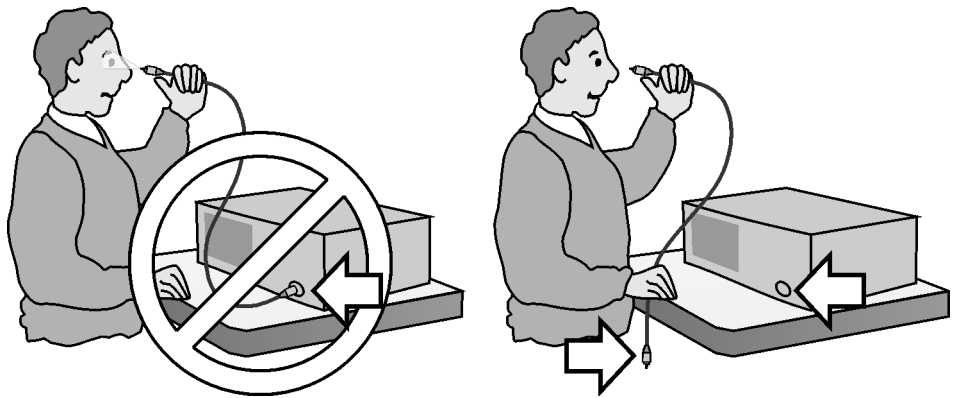

Because fiber-optic connectors are susceptible to damage that is not immediately obvious to the naked eye, bad measurements can be made without the user even being aware of a connector problem. Although microscopic examination and return loss measurements are the best way to ensure good connections, they are not always practical. An awareness of potential problems, along with good cleaning practices, can ensure that optimum connector performance is maintained. With glass-to-glass interfaces, it is clear that any degradation of a ferrule or the end of the fiber, any stray particles, or finger oil can have a significant effect on connector performance.

Figure 4 shows the end of a clean fiber-optic cable. The dark circle in the center of the micrograph is the fiber's 125 μm core and cladding which carries the light. The surrounding area is the soft nickel-silver ferrule.

Figure 5 shows a dirty fiber end from neglect or perhaps improper cleaning. Material is smeared and ground into the end of the fiber causing light scattering and poor reflection. Not only is the precision polish lost, but this action can grind off the glass face and destroy the connector.

Figure 6 shows physical damage to the glass fiber end caused by either repeated connections made without removing loose particles or using improper cleaning tools. When severe, the damage on one connector end can be transferred to another good connector that comes in contact with it.

The cure for these problems is disciplined connector care as described in the following list and in “Cleaning Connectors” on page 45.

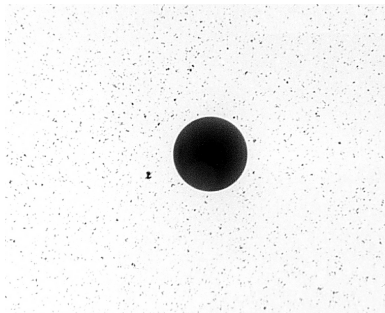

Figure 4 Clean, problem-free fiber end and ferrule.

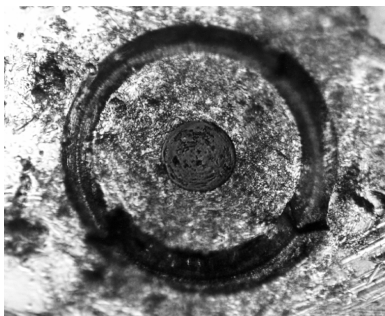

Figure 5 Dirty fiber end and ferrule from poor cleaning.



Figure 6 Damage from improper cleaning.

Use the following guidelines to achieve the best possible performance when making measurements on a fiber-optic system:

- Never use metal or sharp objects to clean a connector and never scrape the connector.
- Avoid matching gel and oils.

While these often work well on first insertion, they are great dirt magnets. The oil or gel grabs and holds grit that is then ground into the end of the fiber. Also, some early gels were designed for use with the FC, non-contacting connectors, using small glass spheres. When used with contacting connectors, these glass balls can scratch and pit the fiber. If an index matching gel or oil must be used, apply it to a freshly cleaned connector, make the measurement, and then immediately clean it off. Never use a gel for longer-term connections and never use it to improve a damaged connector. The gel can mask the extent of damage and continued use of a damaged fiber can transfer damage to the instrument.

- When inserting a fiber-optic cable into a connector, gently insert it in as straight a line as possible. Tipping and inserting at an angle can scrape material off the inside of the connector or even break the inside sleeve of connectors made with ceramic material.
- When inserting a fiber-optic connector into a connector, make sure that the fiber end does not touch the outside of the mating connector or adapter.
- Avoid over tightening connections.

Unlike common electrical connections, tighter is *not* better. The purpose of the connector is to bring two fiber ends together. Once they touch, tightening only causes a greater force to be applied to the delicate fibers. With connectors that have a convex fiber end, the end can be pushed off-axis resulting in misalignment and excessive return loss. Many measurements are actually improved by backing off the connector pressure. Also, if a piece of grit does happen to get by the cleaning procedure, the tighter connection is more likely to damage the glass. Tighten the connectors just until the two fibers touch.

- Keep connectors covered when not in use.
- Use fusion splices on the more permanent critical nodes. Choose the best connector possible. Replace connecting cables regularly. Frequently measure the return loss of the connector to check for degradation, and clean every connector, every time.

All connectors should be treated like the high-quality lens of a good camera. The weak link in instrument and system reliability is often the inappropriate use and care of the connector. Because current connectors are so easy to use, there tends to be reduced vigilance in connector care and cleaning. It takes only one missed cleaning for a piece of grit to permanently damage the glass and ruin the connector.

Measuring insertion loss and return loss

Consistent measurements with your lightwave equipment are a good indication that you have good connections. Since return loss and insertion loss are key factors in determining optical connector performance they can be used to determine connector degradation. A smooth, polished fiber end should produce a good return-loss measurement. The quality of the polish establishes the difference between the "PC" (physical contact) and the "Super PC" connectors. Most connectors today are physical contact which make glass-to-glass connections, therefore it is critical that the area around the glass core be clean and free of scratches. Although the major area of a connector, excluding the glass, may show scratches and wear, if the glass has maintained its polished smoothness, the connector can still provide a good low level return loss connection.

If you test your cables and accessories for insertion loss and return loss upon receipt, and retain the measured data for comparison, you will be able to tell in the future if any degradation has occurred. Typical values are less than 0.5 dB of loss, and sometimes as little as 0.1 dB of loss with high performance connectors. Return loss is a measure of reflection: the less reflection the better (the larger the return loss, the smaller the reflection). The best physically contacting connectors have return losses better than 50 dB, although 30 to 40 dB is more common.

Visual inspection of fiber ends

Visual inspection of fiber ends can be helpful. Contamination or imperfections on the cable end face can be detected as well as cracks or chips in the fiber itself. Use a microscope (100X to 200X magnification) to inspect the entire end face for contamination, raised metal, or dents in the metal as well as any other imperfections. Inspect the fiber for cracks and chips. Visible imperfections not touching the fiber core may not affect performance (unless the imperfections keep the fibers from contacting).

Cleaning Connectors

The procedures in this section provide the proper steps for cleaning fiber-optic cables and Agilent Technologies universal adapters. The initial cleaning, using the alcohol as a solvent, gently removes any grit and oil. If a caked-on layer of material is still present, (this can happen if the beryllium-copper sides of the ferrule retainer get scraped and deposited on the end of the fiber during insertion of the cable), a second cleaning should be performed. It is not uncommon for a cable or connector to require more than one cleaning.

CAUTION

Agilent Technologies strongly recommends that index matching compounds *not* be applied to their instruments and accessories. Some compounds, such as gels, may be difficult to remove and can contain damaging particulates. If you think the use of such compounds is necessary, refer to the compound manufacturer for information on application and cleaning procedures.

Table 6 Cleaning Accessories

Item	Agilent Part Number
Isopropyl alcohol	8500-5344
Cotton swabs	8520-0023
Small foam swabs	9300-1223
Compressed dust remover (non-residue)	8500-6659

Table 7 Dust Caps Provided with Lightwave Instruments

Item	Agilent Part Number
Laser shutter cap	08145-64521
FC/PC dust cap	08154-44102
Biconic dust cap	08154-44105
DIN dust cap	5040-9364
HMS10/dust cap	5040-9361
ST dust cap	5040-9366

To clean a non-lensed connector**CAUTION**

Do not use any type of foam swab to clean optical fiber ends. Foam swabs can leave filmy deposits on fiber ends that can degrade performance.

- 1 Apply pure isopropyl alcohol to a clean lint-free cotton swab or lens paper.

Cotton swabs can be used as long as no cotton fibers remain on the fiber end after cleaning.

- 2 Clean the ferrules and other parts of the connector while avoiding the end of the fiber.
- 3 Apply isopropyl alcohol to a new clean lint-free cotton swab or lens paper.
- 4 Clean the fiber end with the swab or lens paper.

Do *not* scrub during this initial cleaning because grit can be caught in the swab and become a gouging element.

- 5 Immediately dry the fiber end with a clean, dry, lint-free cotton swab or lens paper.
- 6 Blow across the connector end face from a distance of 6 to 8 inches using filtered, dry, compressed air. Aim the compressed air at a shallow angle to the fiber end face.

Nitrogen gas or compressed dust remover can also be used.

CAUTION

Do not shake, tip, or invert compressed air canisters, because this releases particles in the can into the air. Refer to instructions provided on the compressed air canister.

7 As soon as the connector is dry, connect or cover it for later use.

If the performance, after the initial cleaning, seems poor try cleaning the connector again. Often a second cleaning will restore proper performance. The second cleaning should be more arduous with a scrubbing action.

WARNING

Always remove both ends of fiber-optic cables from any instrument, system, or device before visually inspecting the fiber ends. Disable all optical sources before disconnecting fiber-optic cables. Failure to do so may result in permanent injury to your eyes.

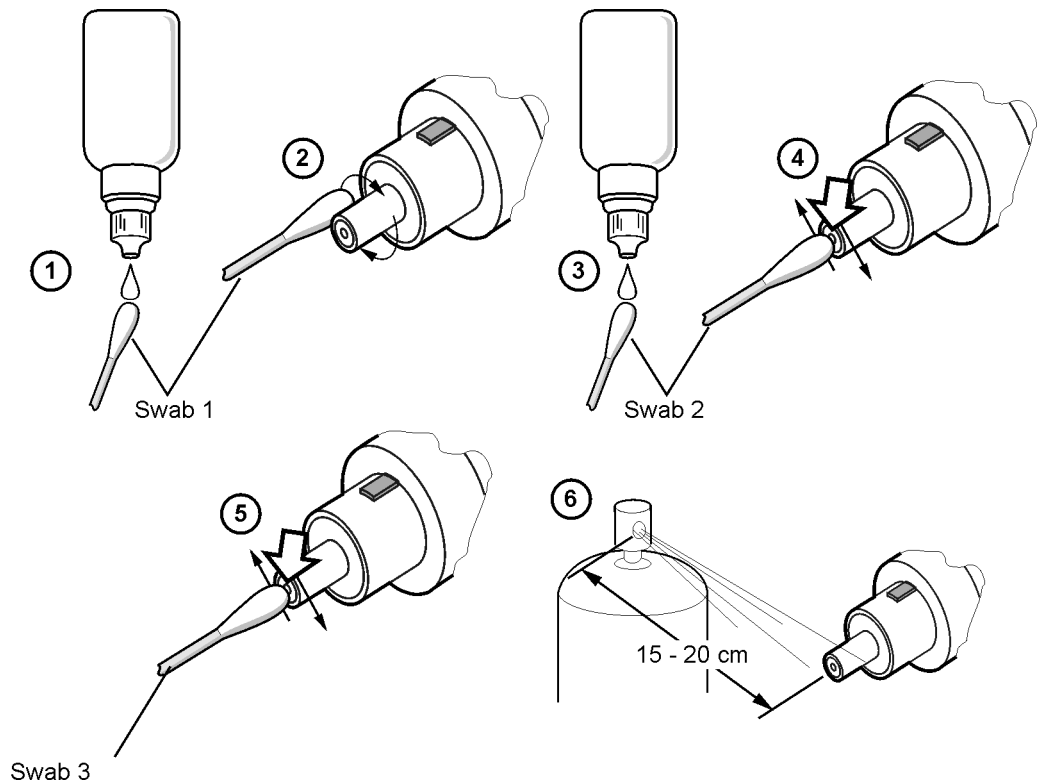

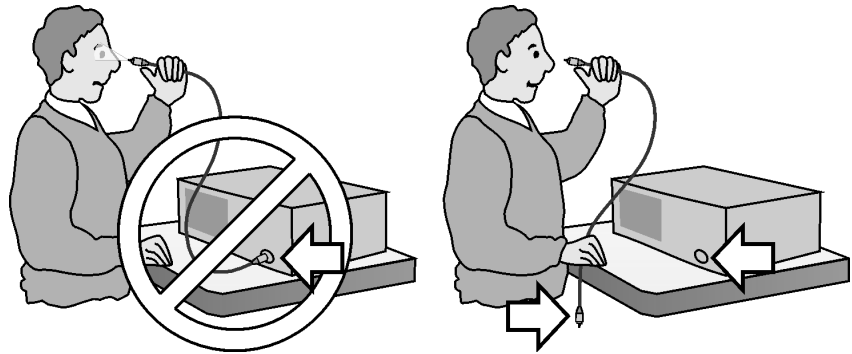

To clean an adapter

The fiber-optic input and output connectors on many Agilent Technologies instruments employ a universal adapter such as those shown in the following picture. These adapters allow you to connect the instrument to different types of fiber-optic cables.



Figure 7 Universal adapters.

- 1** Apply isopropyl alcohol to a clean foam swab.

Cotton swabs can be used as long as no cotton fibers remain after cleaning. The foam swabs listed in this section's introduction are small enough to fit into adapters.

Although foam swabs can leave filmy deposits, these deposits are very thin, and the risk of other contamination buildup on the inside of adapters greatly outweighs the risk of contamination by foam swabs.

- 2** Clean the adapter with the foam swab.
- 3** Dry the inside of the adapter with a clean, dry, foam swab.
- 4** Blow through the adapter using filtered, dry, compressed air.

Nitrogen gas or compressed dust remover can also be used. Do not shake, tip, or invert compressed air canisters, because this releases particles in the can into the air. Refer to instructions provided on the compressed air canister.

Returning the Instrument for Service

The instructions in this section show you how to properly package the instrument for return to a Agilent Technologies service office. For a list of offices, refer to [“Agilent Technologies Service Offices”](#) on page 52.

If the instrument is still under warranty or is covered by an Agilent maintenance contract, it will be repaired under the terms of the warranty or contract (the warranty is at the front of this manual). If the instrument is no longer under warranty or is not covered by an Agilent maintenance plan, Agilent will notify you of the cost of the repair after examining the unit.

When an instrument is returned to a Agilent service office for servicing, it must be adequately packaged and have a complete description of the failure symptoms attached.

When describing the failure, please be as specific as possible about the nature of the problem. Include copies of additional failure information (such as the instrument failure settings, data related to instrument failure, and error messages) along with the original cal data disks and the instrument being returned.

Please notify the service office before returning your instrument for service. Any special arrangements for the instrument can be discussed at this time. This will help the Agilent service office repair and return your instrument as quickly as possible.

Preparing the instrument for shipping

- 1 Write a complete description of the failure and attach it to the instrument. Include any specific performance details related to the problem. The following information should be returned with the instrument.
 - Type of service required.
 - Date instrument was returned for repair.
 - Description of the problem:
 - Whether problem is constant or intermittent.
 - Whether instrument is temperature-sensitive.
 - Whether instrument is vibration-sensitive.
 - Instrument settings required to reproduce the problem.
 - Performance data.
 - Company name and return address.
 - Name and phone number of technical contact person.
 - Model number of returned instrument.
 - Full serial number of returned instrument.
 - List of any accessories returned with instrument.
 - The original cal data disks.
- 2 Cover all front or rear-panel connectors that were originally covered when you first received the instrument.

CAUTION

Cover electrical connectors to protect sensitive components from electrostatic damage. Cover optical connectors to protect them from damage due to physical contact or dust.

CAUTION

Instrument damage can result from using packaging materials other than the original materials. Never use styrene pellets as packaging material. They do not adequately cushion the instrument or prevent it from shifting in the carton. They may also cause instrument damage by generating static electricity.

- 3 Pack the instrument in the original shipping containers. Original materials are available through any Agilent office. Or, use the following guidelines:
 - Wrap the instrument in antistatic plastic to reduce the possibility of damage caused by electrostatic discharge.
 - For instruments weighing less than 54 kg (120 lb), use a double-walled, corrugated cardboard carton of 159 kg (350 lb) test strength.

- The carton must be large enough to allow approximately 7 cm (3 inches) on all sides of the instrument for packing material, and strong enough to accommodate the weight of the instrument.
 - Surround the equipment with approximately 7 cm (3 inches) of packing material, to protect the instrument and prevent it from moving in the carton. If packing foam is not available, the best alternative is S.D-240 Air Cap™ from Sealed Air Corporation (Commerce, California 90001). Air Cap looks like a plastic sheet filled with air bubbles. Use the pink (antistatic) Air Cap™ to reduce static electricity. Wrapping the instrument several times in this material will protect the instrument and prevent it from moving in the carton.
- 4** Seal the carton with strong nylon adhesive tape.
 - 5** Mark the carton “FRAGILE, HANDLE WITH CARE”.
 - 6** Retain copies of all shipping papers.

Agilent Technologies Service Offices

Call Center

For technical assistance, you can contact your local Agilent Call Center.

- Visit <http://www.agilent.com> and click Contact Us.

Also see “Agilent Technologies Sales and Service Offices” on page iv

Service Center

Before returning an instrument for service, you must first call the Agilent Technologies Instrument Support Center.

- In all regions, call +1(800) 829-4444

Hard Drive Backup and Recovery

Use the following procedure to back up or restore the operating system on an Agilent Technologies instrument/system running on a MS Windows platform.

NOTE

MS Windows based instruments must have a keyboard attached prior to starting this procedure.

- 1 Insert the System Utility disk (Agilent part number 5011-1306) into the floppy drive.
- 2 Restart the instrument/system controller.
- 3 When the Agilent Technologies System Utilities Screen appears, select from the following options:

Recover Factory's Backup Image

This process restores your system to the original, factory-installed operating system and system software. A recovery should be done if MS Windows is corrupted or if you have been instructed to do so by an Agilent service engineer.

Create User Backup Image

This process creates a backup image of your system. This process should be done if you have modified the network parameters and/or drivers, or if you have updated the system software.

Recover User Backup Image

This process restores your system to the user-created backup image. A recovery should be done if MS Windows is corrupted or if you have been instructed to do so by an Agilent service engineer.

Exit

Exits the utility.

- 4 Enter the number associated with the desired action. For example, enter 2 if you want to create a user backup image of your system.
- 5 The procedure will begin. Follow the onscreen instructions to complete the process. The procedure will take approximately 10 to 20 minutes to complete.
- 6 When the process is finished, remove the floppy disk from the disk drive and restart the instrument/system controller.

Create a New System Utility Disk

Follow the steps below to create a new system utility disk:

- 1 On the Utilities menu, click Protected Functions.
- 2 Enter the protected functions password “exit to windows” and click Activate.

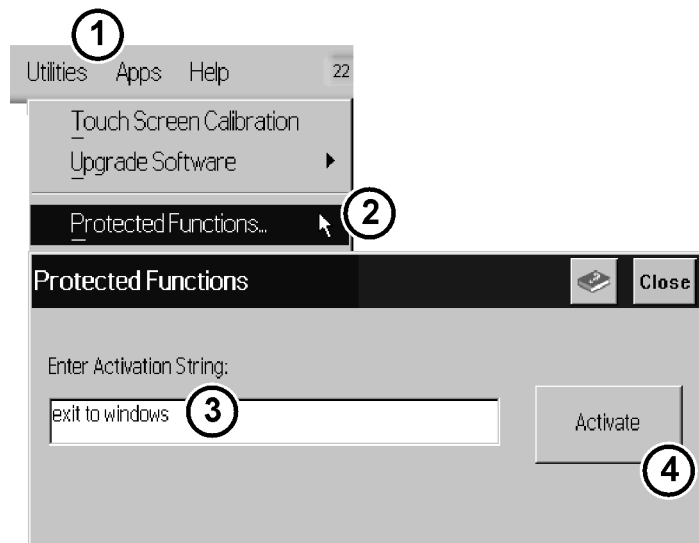

- 3 On the Start menu, point to 86122A Tools, and then click Create Recovery Disk.
- 4 Insert a floppy disk, click OK, and then click Create Floppy.
- 5 To return to the 86122A software, cycle the instrument power or click Start, point to Programs, and then click 86122A.



2

Working in Comfort

About Repetitive Strain Injury	56
Mice and Other Input Devices	58

To optimize your comfort and productivity, it is important that you set up your work area correctly and use your Agilent product properly. With this in mind, we have developed some setup and use recommendations for you to follow based on established ergonomic principles.

Improper and prolonged use of keyboards and input devices are among those tasks that have been associated with repetitive strain injury (RSI) to soft tissues in the hands and arms. If you experience discomfort or pain while using your Agilent Technologies product, discontinue use immediately and consult your physician as soon as possible.

Please study the recommendations offered here in this chapter. You may also wish to consult your employer's human resources department or other relevant departments for guidance specific to your company.

About Repetitive Strain Injury

Because your comfort and safety are our primary concern, we strongly recommend that you use the 86122A in accordance with established ergonomic principles and recommendations. Scientific literature suggests that there may be a relationship between injury to soft tissues - especially in the hands and arms - and prolonged improper use of keyboards or other equipment requiring repeated motions of the hands and forearms. This literature also suggests that there are many other risk factor that may increase the chance of such injury, commonly called Repetitive Strain Injury.

What is RSI?

Repetitive Strain Injury (RSI—also known as cumulative trauma disorder or repetitive motion injury) is a type of injury where soft tissues in the body, such as muscles, nerves, or tendons, become irritated or inflamed. RSI has been a reported problem for those who perform repetitive tasks such as assembly line work, meatpacking, sewing, playing musical instruments, and computer work. RSI has also been observed in those who frequently engage in activities such as carpentry, knitting, housework, gardening, tennis, windsurfing and lifting children.

What causes RSI?

The specific causes of RSI have not been established. Nevertheless, the incidence of RSI has been associated with a variety of risk factors, including:

- Too many uninterrupted repetitions of an activity or motion.
- Performing an activity in an awkward or unnatural posture.
- Maintaining a static position for prolonged periods.
- Failing to take frequent short breaks.
- Other environmental and social factors.

In addition, there have been reports associating the occurrence of RSI with the use of keyboards, mice, and other input devices. Also, certain medical conditions, such as rheumatoid arthritis, obesity and diabetes, may predispose people to this type of injury.

What if I experience discomfort?

If you are experiencing any discomfort, seek professional medical advice immediately. Typically, the earlier a problem is diagnosed and treated, the easier it is to resolve.

Mice and Other Input Devices

Various aspects of using mice and other input devices may increase your risk of discomfort or injury. Observing the following recommendations may reduce that risk.

- Try to keep your hand, wrist, and forearm in a neutral position while using your mouse or other input device.
- If you use your thumb to rotate the ball on a trackball or spaceball, keep it in a relaxed, natural shape, and maintain a neutral posture in your hand, wrist, and forearm.
- Hold the mouse gently by draping your fingers over it. Keep your hand relaxed and fingers loose. Do not grip the mouse tightly.
- It takes very little pressure or force from your fingers to activate the buttons or scroll wheel on your mouse, scrolling mouse, trackball, or other input device. Using too much force can place unnecessary stress on the tendons and muscles in your hands, wrists, and forearms.
- If you are using a scrolling mouse, be sure to keep your fingers and hand in a relaxed, neutral position when activating the scroll wheel. Also, this type of mouse features software that can minimize the number of mouse movements or button clicks.
- When using a mouse, trackball, or other input device, position it as close to the keyboard as possible, and keep it at the same level as you do not have to stretch while using it.
- Use a good quality mouse pad to enable the mouse to work most effectively and reduce unnecessary hand and wrist movements.
- Be sure to keep your mouse and trackball clean. Regular removal of accumulated dust and dirt helps ensure proper tracking and reduces unnecessary hand and wrist motions.

3

Using the 86122A

Introduction.....	60
Differences Between the 86122A and the 86120C.....	61
Front and Rear Panel Features.....	64
Main Screen Layout.....	66
Graphs and Tables	68
Front Panel Buttons.....	69
Menus	71
86122A Dialog Box Operation	75
Making Measurements.....	76
Step 1. Consider Measurement Limitations	76
Step 2. Select Basic Measurement Setup Parameters.....	78
Step 3. Define Laser-Line Peaks.....	81
Step 4. Make Measurements	83
Step 5. Adjust the Graph to Your Preference	86
Step 6. Save Measurement Results.....	89

Introduction

The Agilent 86122A Multi-Wavelength Meter measures the wavelength and optical power of laser light in the 1270–1650 nm wavelength range. Because the 86122A simultaneously measures multiple laser lines, you can characterize dense-wavelength-division-multiplexed (DWDM) systems and the multiple lines of Fabry-Perot lasers

With the 86122A you can quickly and easily measure the following parameters:

- Up to 1000 laser lines simultaneously
- Wavelengths and powers
- Average wavelength
- Total optical power
- Laser line separation
- Laser drift (wavelength and power)
- Optical signal-to-noise ratios
- Fabry-Perot lasers

This chapter gives you an overview of the front and rear panel, and the graphical user interface. In addition, it explains the steps required to make a measurement.

Differences Between the 86122A and the 86120C

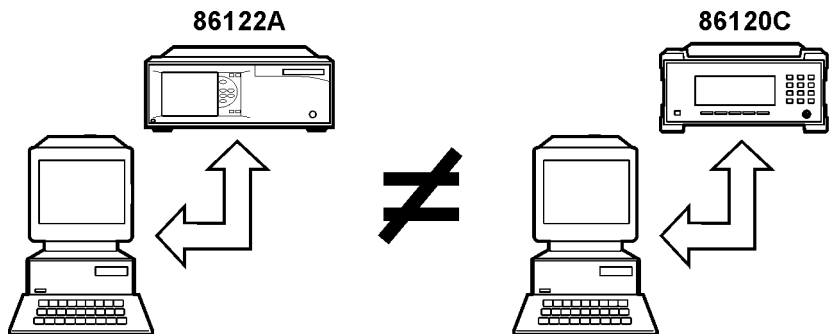

The 86122A is backward compatible with the 86120C. However, because of improvements in the 86122A, there are some operational differences from the 86120C. For your convenience, these differences are listed below:

Differences in General Operation

- Update mode and number of points: The 86120C had two update modes (normal and fast) with two different resolutions (15,047 and 7,525 data points). The 86122A has one update mode (2 sweeps/second) and increased resolution (30,093 data points).

For the 86120C, the command `CALC1:TRAN:FREQ:POIN` selected the normal (MAX) or fast (MIN) update mode. For the 86122A, this command remains for backward compatibility. Without changing the resolution of the 86122A, this command configures the queries `SENSE:DATA?` and `CALC1:DATA?` to return the number of data points used by the 86120C. To return all the data available with the 86122A, use the new parameter `EXT1` (`CALC1:TRAN:FREQ:POIN EXT1`).

- Elevation: There is no need to enter an elevation for the 86122A because it has an internal weather station. The command `SENS:CORR:ELEV` remains for backward compatibility, but has no effect on the 86122A.
- Data logging: This new feature of the 86122A allows you to record measurement data over time for later analysis.
- Drift Application: This application has been enhanced for the 86122A.
- Dropped/added channels: If the number of channels changed during a drift measurement, the 86120C would stop the measurement and generate an error. The 86122A indicates if channels have been dropped or added, and continues the drift measurement. The query `CALC3:DATA? DROP` returns the peaks that have dropped or reappeared during a drift measurement.
- Wavelength masks: The 86122A creates wavelength masks for each laser line, which limit how fast channels can drift without being measured as dropped. With each measurement sweep, these masks re-center around laser lines that have drifted less than 0.002 THz.
- Peak threshold: The 86120C peak threshold could only be set to a relative value. The 86122A peak threshold can be set to a relative or absolute value. The command `CALC2:PTHR:MOD` allows you to select between an absolute or relative peak threshold, and `CALC2:PTHR:ABS` allows you to set the absolute value.

Differences in Remote Commands

- **CALC1:TRAN:FREQ:POIN:** For the 86120C, this command selected the normal (MAX) or fast (MIN) update mode. For the 86122A, this command remains for backward compatibility. Without changing the resolution of the 86122A, this command configures the queries **SENSE:DATA?** and **CALC1:DATA?** to return the number of data points used by the 86120C. To return all the data available with the 86122A, use the new parameter **EXT1** (**CALC1:TRAN:FREQ:POIN EXT1**).
- **SENS:CORR:ELEV:** For the 86122A, this command has no affect, and remains for backward compatibility only. There is no need to enter an elevation for the 86122A because it has an internal weather station.
- **CALC3:DATA? DROP:** For the 86122A, this query returns the peaks that have dropped or reappeared during a drift measurement.
- **CALC2:PTHR:MOD:** For the 86122A, this command allows you to select between an absolute or relative peak threshold.
- **CALC2:PTHR:ABS:** For the 86122A, this command allows you to set the absolute peak threshold value.
- **CONF:** For the 86120C, this command query returned the setting to be used for the default **FETCH** or **READ** commands. For the 86122A, this command query returns the current configuration of the instrument.
- **SYST:VERS?:** This query returns the SCPI compliance version. The 86120C version was 1995.0. The 86122A version is 1999.0.
- **DISP:UNIT:WAV:** This new command allows you to set the wavelength unit of the display.
- **DISP:WIND2:** The new commands in this subsystem allow you to control or query the graphical display settings.
- **HCOP:DEST, HCOP:MODE, HCOP:PRIN:** These new commands allow you to set-up your printer and printout mode.
- **MMEM:** The new commands in this subsystem allow you to manage the mass storage capabilities of the instrument.
- **SYST:DATE** and **SYST:TIME:** These new commands allow you to set or query the date and time.
- **Questionable status register bits 4 and 12:** The 86122A uses these bits.
- **Power offset:** The 86120C does not apply the current power offset to power values returned from the **FETC:ARR/SCAL:POW?** and **CALC2:DATA? POW** commands. The 86122A does apply the power offset to these commands.
- **Inverse centimeters and inverse meters unit suffix:** The 86120C applied an incorrect conversion for values with the **/CM** or **/M** suffix when converting to a commands internal unit (often Hertz). The 86122A correctly converts **/CM** and **/M** to the corresponding internal value.

Front and Rear Panel Features

Rear Panel

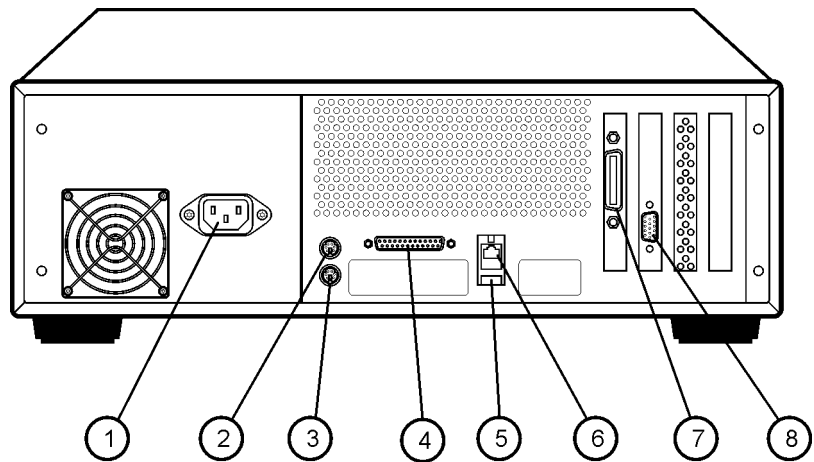

- 1 Power: AC line
- 2 Mouse: PS/2 for optional mouse
- 3 Keyboard: PS/2 for optional keyboard
- 4 Printer: Parallel printer port
- 5 USB: For a USB keyboard and mouse. USB printers are not supported.
- 6 LAN: A keyboard must be used to set up LAN connectivity
- 7 GPIB: Fully programmable, complies with IEEE 488.2
- 8 Video Output: SVGA

NOTE

An optional rear-panel optical input is also available.

Front Panel

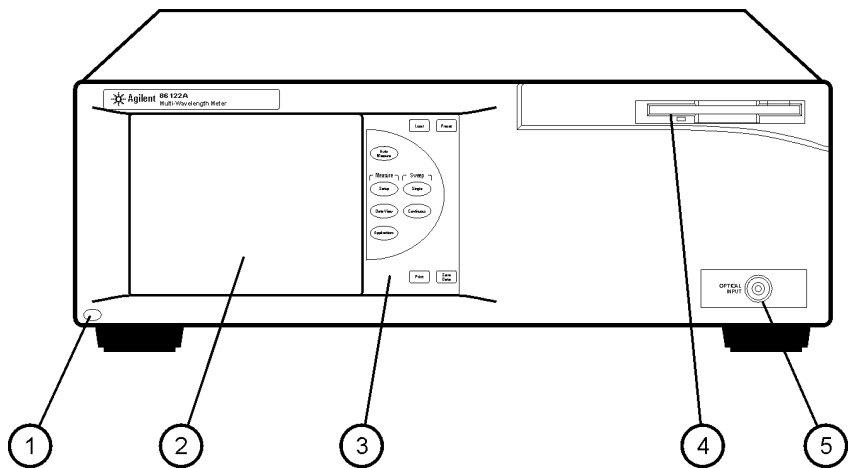

- 1 Line button
- 2 Display screen
- 3 Front panel buttons
- 4 3.5-inch disk drive
- 5 Optical Input: 9/125 μm single-mode fiber

Main Screen Layout

The main screen of the 86122A is shown below:

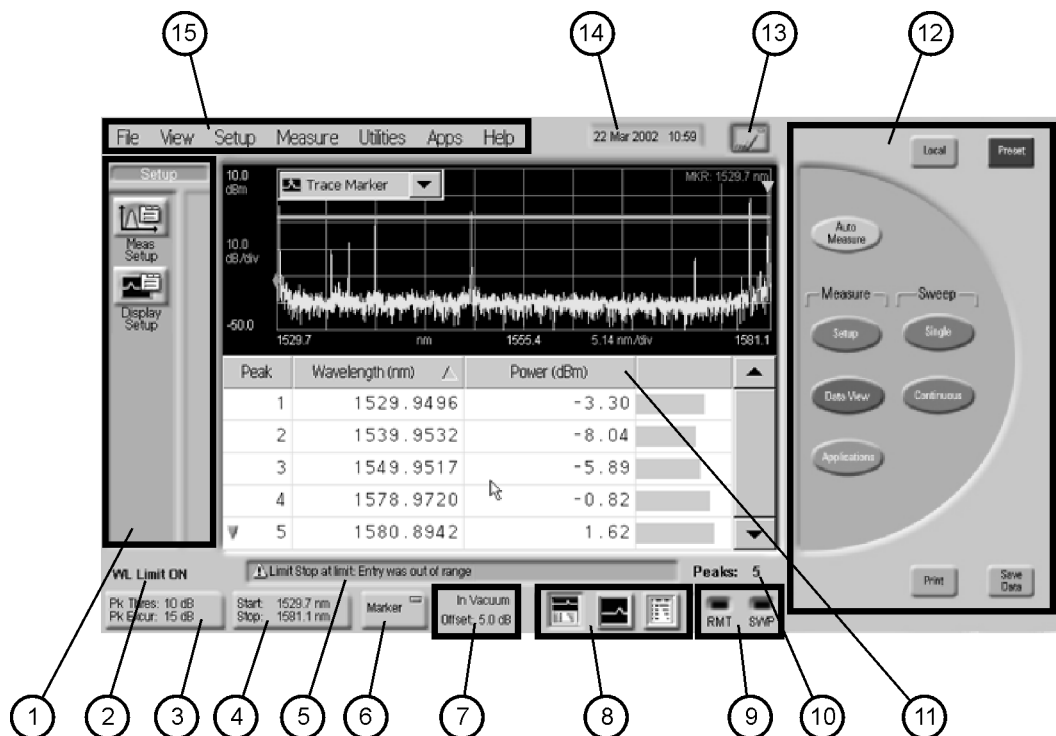

The basic main screen components are described below. For more detailed information, refer to the Help.

1 Instrument Toolbars: You can use the graphical toolbar to easily access measurement setup, data view, and application functions. There is a dedicated toolbar for each function. To open the desired toolbar, press the front panel button that corresponds with the functions you want to perform.



2 Wavelength Limiting Status: Displays the wavelength limiting state.

3 Peak Criteria Button: Click this button to access the peak criteria settings and change the definition of peak.

4 Graph Limit Button: Click this button access the graph limits settings and define the x-axis limits of the graphical display.

- 5** Error Message Display Box: This area displays information about the status of the instrument or an action that has been performed. Messages also appear to inform you of errors that may have occurred.
- 6** Marker Button: Click this button to enable or disable the trace marker.
- 7** Medium and Offset: Displays the selected medium and power offset setting.
- 8** Data Display Buttons: These buttons allow you to can select one of three types of data displays: split display, graph only, or table only.
- 9** Remote and Sweep Indicators: These indicators display the operating and acquisition status of the instrument. When the instrument is in the remote operating mode or is acquiring data, the corresponding indicator is lit.
- 10** Number of Peaks Status: This indicator displays the number of peaks currently detected that meet the specified peak criteria.
- 11** Graphical Display: The Agilent 86122A has a high-resolution touch screen that allows easy navigation of the instrument. You can also use a mouse. The graphical display shows the transformed, uncorrected frequency-domain measurement data in a spectrum analyzer type graph.
- 12** Front Panel Buttons: The 10 front panel buttons can be accessed with your finger or a stylus.
- 13** Touch Screen Enable/Disable Button: Click or touch this button to disable the pointing devices (touch screen and mouse). The indicator on the button changes from green to red.

When you disable the pointing devices, the mouse is confined to the region surrounding the disable button. You can then touch the graphical display without initiating a change to the instrument.

If you touch anywhere on the graphical display when the pointing devices are disabled, the disable button flashes yellow. To enable the pointing devices, click or touch this button again. The graphical display returns to its normal operating condition.
- 14** Set Time and Date: Click this button to access the time and date controls. The instrument uses the date and time when performing various functions. For example,
 - data logging
 - listing files in MMEMory subsystem commands
 - saving files
 - saving screen images
 - printing
- 15** Instrument Menus: The instrument menus provide access to all functions.

Graphs and Tables

This section describes the layout of the graph and table.

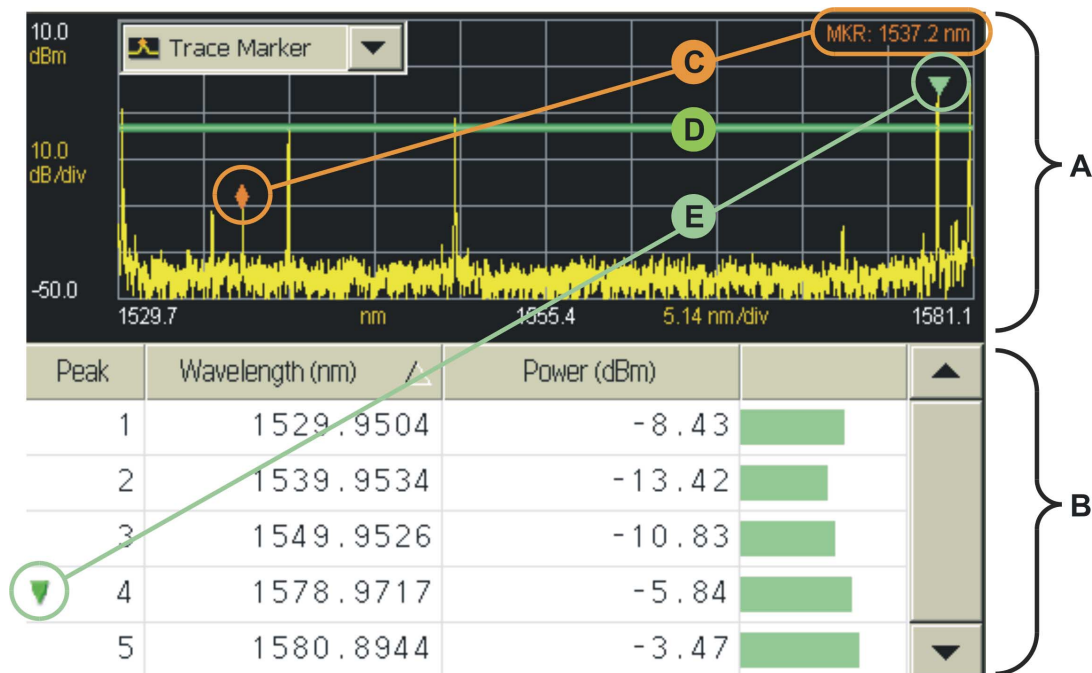

- A** The graph displays a measurement trace that plots wavelength versus power for the entire span of the graph.
- B** The table lists precise measurement data for peak wavelengths.
- C** The trace marker allows you to find the approximate wavelength of any point on the measurement trace. An area in the upper right corner of the graph displays the approximate trace marker wavelength, but not power.
- D** The horizontal green line represents the peak threshold, one of two criteria used to define peak wavelengths. For more information, refer to Peak Criteria.
- E** The peak marker is always displayed and allows you to associate a peak wavelength in the graph with a row of peak data in the table.

Front Panel Buttons

The touch screen extends to the right of the LCD display. This area contains ten touchkeys buttons that can be accessed with your finger or a stylus. These are referred to as the front panel buttons. This section explains the function of each front panel button.

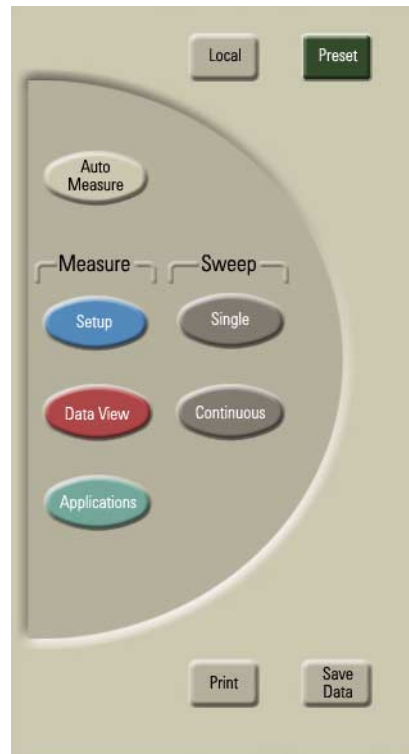

Press this button to return control of the instrument to the front panel. The Local and AC power buttons are the only front panel controls active when the instrument is in remote operation.



Press this button to return the instrument to its factory default conditions. The exceptions are

Press this button to return the instrument to its factory default conditions. The exceptions are

- GPIB address
- references
- Printout type
- OSNR user wavelength
- Don't Show this Dialog on Startup check box



Press this button to exit the current measurement application and initiate an auto-measurement sequence.



Press this button to open the Setup toolbar. You can then modify a variety of measurement and display setup functions.



Press this button to open the Data View toolbar. You can then configure the tabular display as desired.



Press this button to open the Applications toolbar. You can then select your desired measurement application.



Press this button to place the instrument in single sweep mode and initiate a single sweep of the instrument.



Press this button to place the instrument in continuous sweep mode and initiate sweeping.



Press this button to open the Save Meas Data dialog box. Select a file name and click Save.



Press this button to open the Print Setup dialog box. Select the Default Printer and Printout Type, and click Print.

Menus

The instrument menus provide access to all functions. This section shows the layout of each menu. For detailed information on each of these menus, refer to the Help.

The File menu

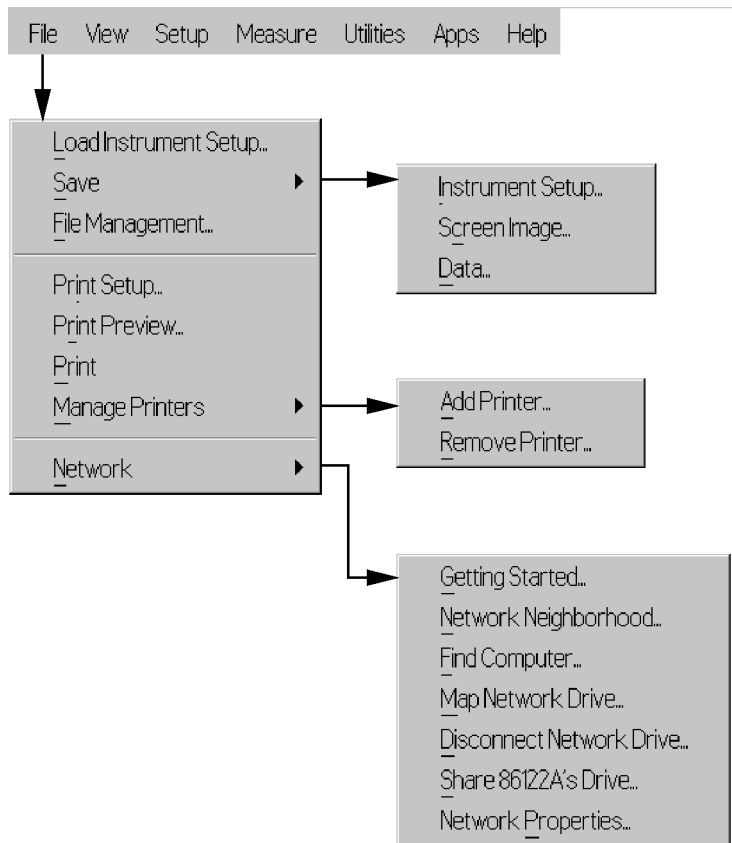

The View menu

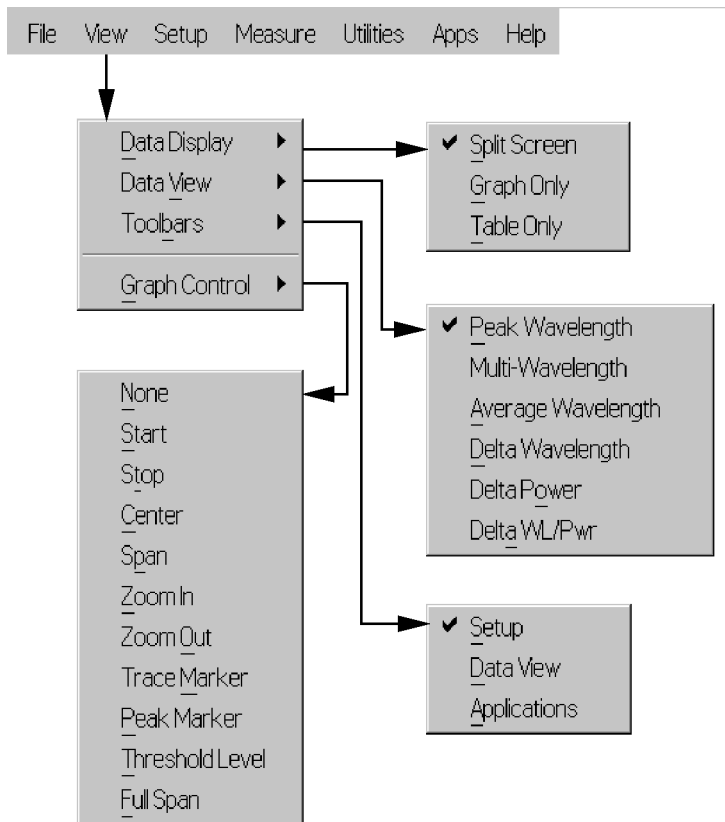

The Setup menu

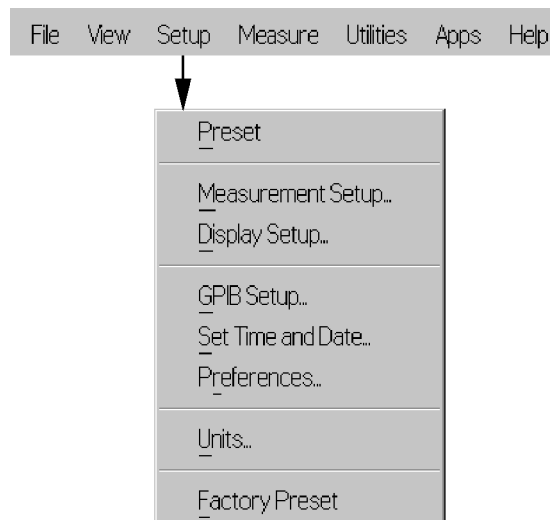

The Measure menu

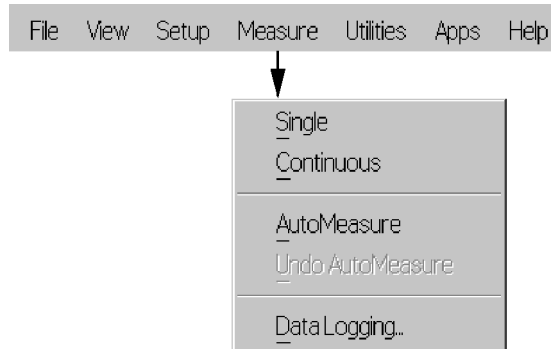

The Utilities menu

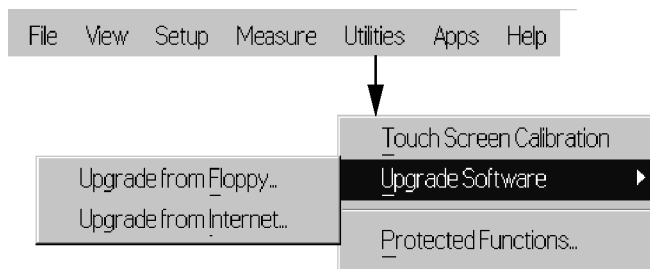

The Apps menu

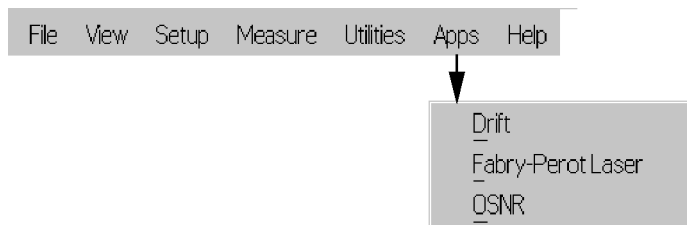

The Help menu

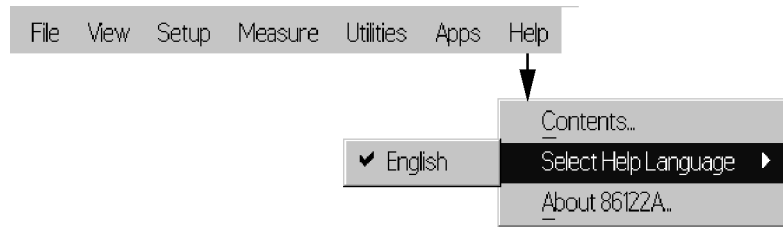

86122A Dialog Box Operation

The 86122A dialog boxes allow real-time changes to instrument settings. Because of this, the dialog boxes do not have OK, Apply, and Cancel buttons. When you have finished changing a setting, simply click Close.

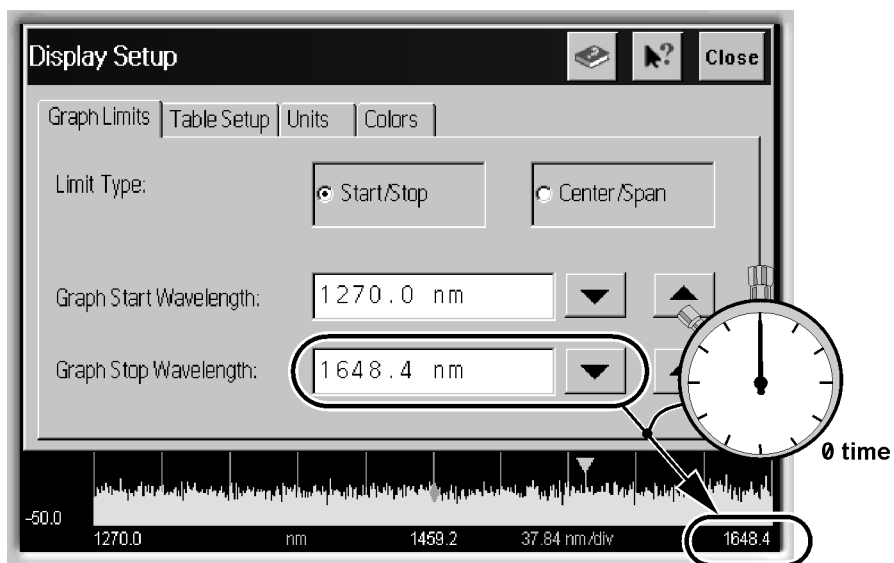

Making Measurements

The rest of this chapter explains the steps required to make a measurement.

Step 1. Consider Measurement Limitations

Before connecting a signal and making a measurement, please consider the following measurement limitations:

NOTE

The front-panel OPTICAL INPUT connector uses a single-mode input fiber.

CAUTION

+10 dBm is the maximum total displayed input power. Do not exceed +18 dBm source power. The Agilent 86122A's input circuitry can be damaged when total input power exceeds this level.

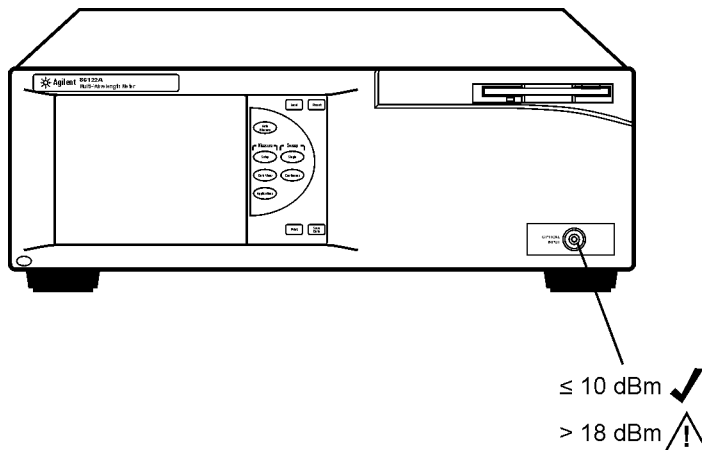

CAUTION

Optical channel fiber-optic connectors are easily damaged when connected to dirty or damaged cables and accessories. When you use improper cleaning and handling techniques, you risk expensive instrument repairs, damaged cables, and compromised measurements. Before you connect any fiber-optic cable to the Agilent Variable Optical Attenuator modules and Agilent Variable Optical Attenuator modules with Power Control, refer to [“Cleaning Connections for Accurate Measurements”](#) on page 38.

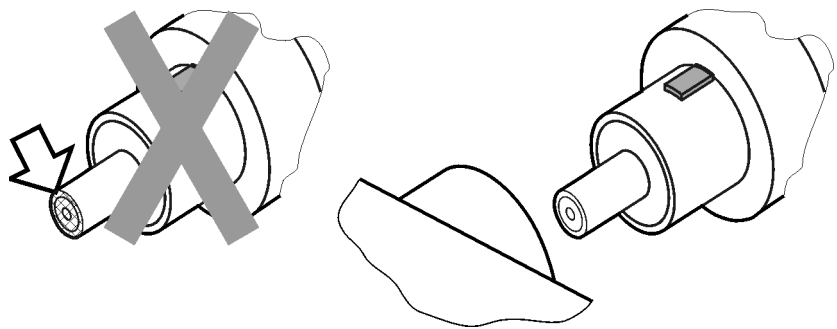
**WARNING**

Always remove both ends of fiber-optic cables from any instrument, system, or device before visually inspecting the fiber ends. Disable all optical sources before disconnecting fiber-optic cables. Failure to do so may result in permanent injury to your eyes.

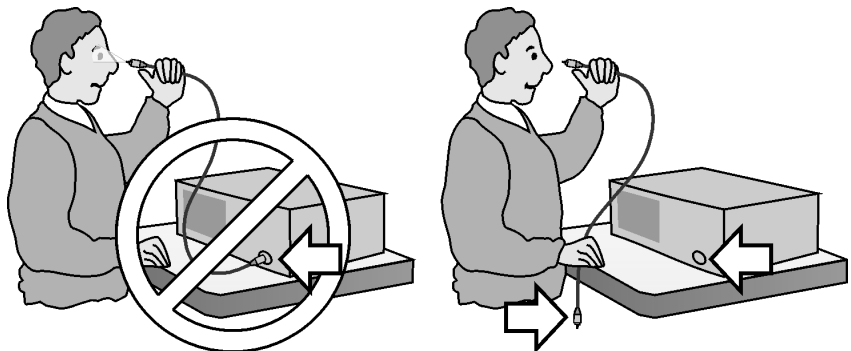

- If the measured amplitudes are low, clean the front-panel OPTICAL INPUT connector.
- 1270 - 1650 nm is the maximum input wavelength range
- Laser line widths are assumed to be less than 2.5 GHz

Step 2. Select Basic Measurement Setup Parameters

Basic measurement setup parameters that you should choose before making a measurement are medium, device type, units, and sweep mode.

Select the Medium

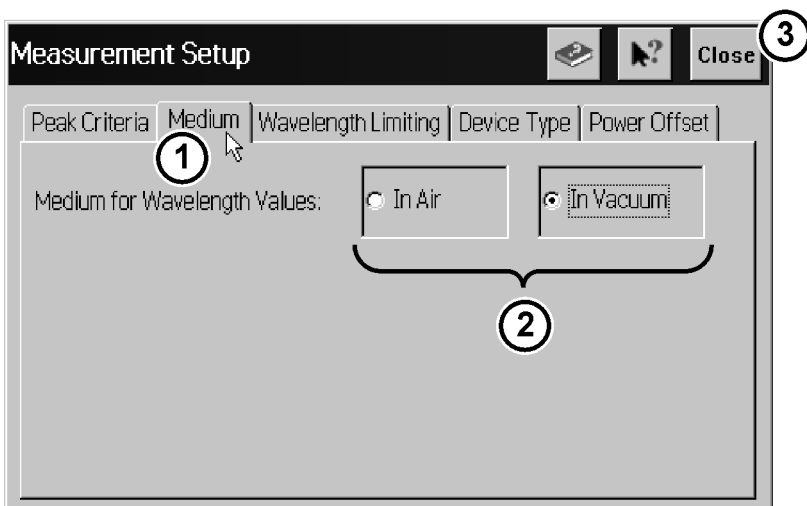

The 86122A can display wavelength values in a vacuum, or in standard air.

- 1 Press  and click .
- 2 Click the Medium tab, and select In Air or In Vacuum.
- 3 Click Close.



Select the Units

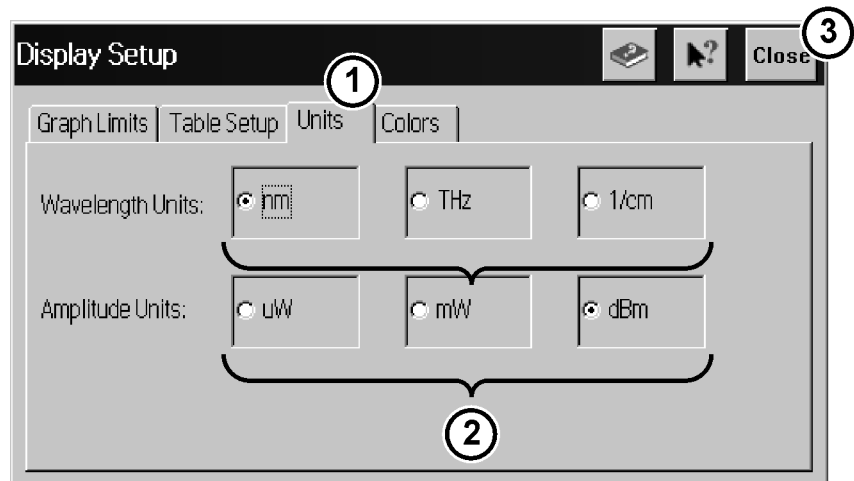

The 86122A can display wavelength and amplitude values in several types of measurement units.

- 1 Press  and click .
- 2 Click the Units tab, and select the wavelength and amplitude units.
- 3 Click Close.



Select the Device Type

You can optimize (or match) the measurement technique of the 86122A to the type of device you are measuring – narrowband or broadband. Narrowband devices include DFB lasers and modes of Fabry-Perot lasers. Broadband devices include LEDs, optical filters, and chirped lasers.

- 1 Press  and click .
- 2 Click the Device Type tab, and select Narrowband or Broadband.
- 3 Click Close.

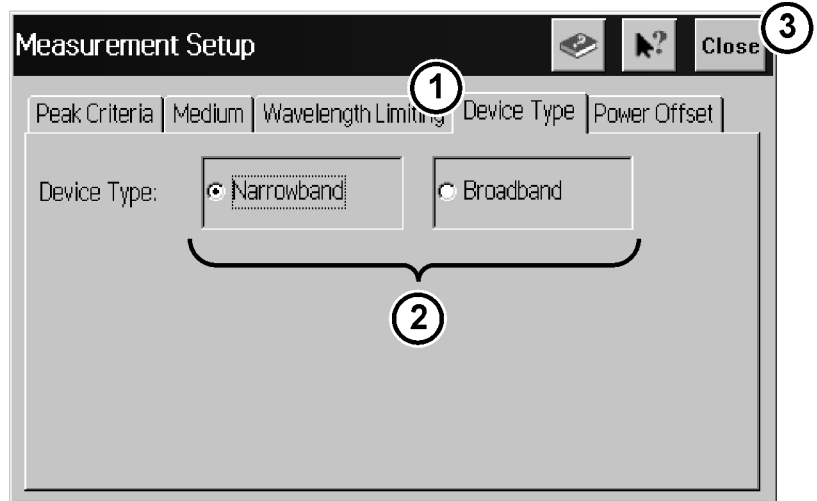

Select the Sweep Mode

- Press **Single** to initiate one measurement sweep. This is useful if you want the data to remain static for saving results or printing.
- Press **Continuous** to continuously measure the input spectrum. In this mode, a measurement sweeps occurs approximately every 0.5 seconds. This is useful if you want the data to be continuously updated.

You can also set up data logging to perform measurement sweeps at any desired interval. The green SWP indicator in the lower right-hand corner is lit when a measurement is being acquired.

Step 3. Define Laser-Line Peaks

Peak criteria settings and wavelength limiting allow you to define how laser line peaks are measured.

How Laser-Line Peaks are Defined

A laser line will only be measured as a peak if the amplitude is greater than the peak threshold limit and the rise-and-fall (excursion) is greater than or equal to the peak excursion. In addition, peaks are only measured within the wavelength limits that you specify.

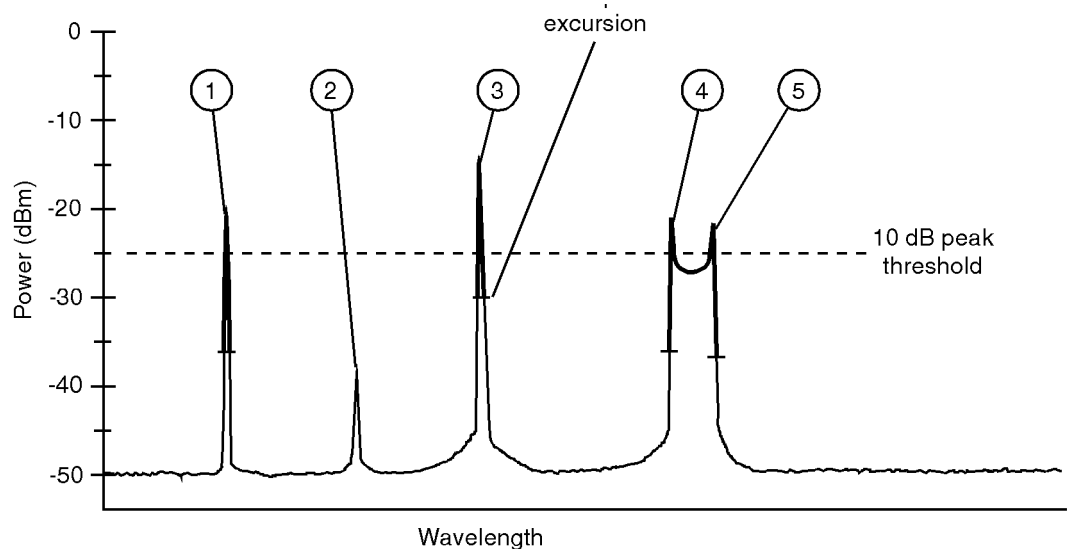

- In this figure, only three laser lines are identified as peaks: responses 1, 3, and 4.
- Response 2 is not identified as a peak because it is below the peak threshold.
- Responses 4 and 5 are identified as one peak laser line. This is because the minimum point between 4 and 5 does not drop to the peak excursion limit.



Use Peak Criteria to Define Peaks

- 1 Click  .
- 2 Click the Peak Criteria tab.
- 3 Select Relative or Absolute threshold type.
- 4 Click the Threshold Value box and enter the threshold value.

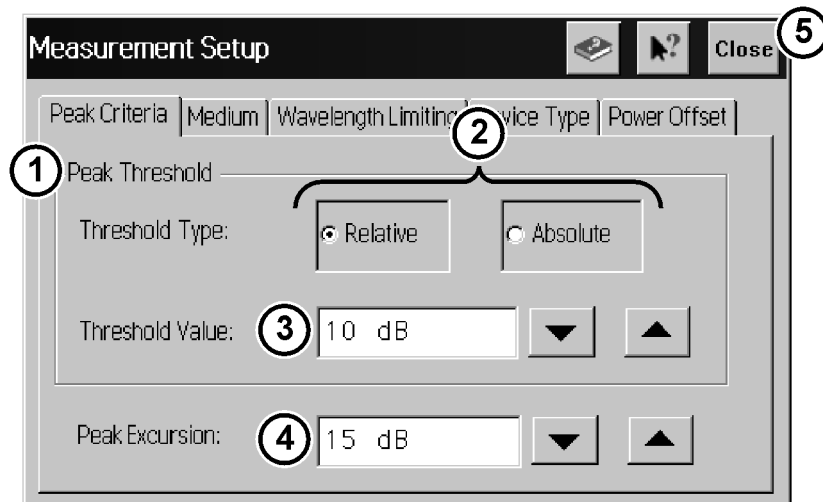
- 5 Click the Peak Excursion box and enter the excursion value.
- 6 Click Close.



Use Wavelength Limiting to Define Peaks

- 1 Press  and click .
- 2 Click the Wavelength Limiting tab.
- 3 Select On
- 4 Click the Limit Start Wavelength box and enter the start wavelength value.
- 5 Click the Limit Stop Wavelength box and enter the stop wavelength value.
- 6 Click Close.

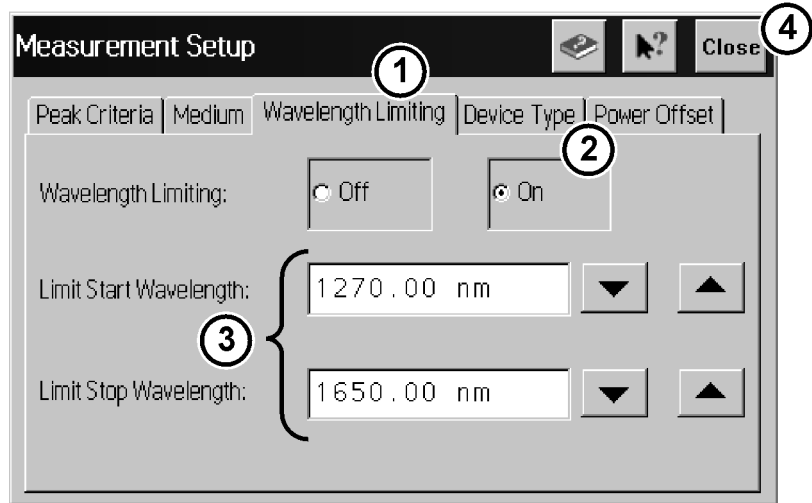

Step 4. Make Measurements

The 86122A can make a wide variety of wavelength and power measurements.

Peak Wavelength and Power

Press  and click .

Multiple Laser Lines



Press  and click .

Average Wavelength and Total Power

Press  and click .



Laser Channel Separation

It is often important to measure the wavelength and power separation between multiple laser lines. This is especially true in wavelength-division-multiplexed (WDM) systems where channel spacing must be adhered to. The Agilent 86122A can display the wavelength and amplitude of any laser line relative to another.

- 1 Press  and click  .
- 2 Select a channel as the reference by clicking in the “Ref” column of the desired row.
- 3 To determine channel spacing from the reference, simply read the relative wavelength values in the “Delta WL” column.

Laser Channel Flatness

You can use relative power measurements to measure flatness (pre-emphasis) in a WDM system. Simply select one carrier as the reference and measure the remaining carriers relative to the reference level. The power differences represent the system flatness.

- 1 Press  and click  .
- 2 Select the channel with the largest amplitude as the reference by clicking in the “Ref” column of that peak’s row.
- 3 To determine channel flatness from the reference, simply read the relative power values in the “Delta Pwr” column.

Laser Channel Separation/Flatness

You can also measure channel separation and flatness at the same time.

- Press  and click  .

Laser Drift

Laser drift can be easily measured by using the drift application.

- Press  and click  .



Signal-to-Noise Ratio

Signal-to-noise ratio can be easily measured by using the OSNR application.

Press  and click  .

Fabry-Perot Lasers

Fabry-Perot lasers can be easily measured by using the Fabry-Perot Laser application.

Press  and click  .

Power Greater than 10 dBm

The maximum total input power that can be measured is 10 dBm. However, with the addition of an external attenuator, more power can be applied. This may be necessary at the transmit end of a wavelength-division-multiplexed system where large signal levels are present. By entering a power offset equal to the amount of attenuation at the instrument's input, accurate amplitude measurements are shown on the display.

- 1 Connect an optical attenuator between the front-panel OPTICAL INPUT connector and the fiber-optic cable from your device. The attenuator must reduce the total input power to the Agilent 86122A so that it is below +10 dBm.

2 Press  and click  .

3 Click the Power Offset tab.

4 Click the Power Offset box, and enter a power offset value.

5 Click Close.

Power offset values are added to the display power readings. For example, if you placed a 10-dB attenuator on the front-panel connector, you should enter a power offset value of +10 dB. Negative values can also be entered if you connect an amplifier instead of an attenuator.

Step 5. Adjust the Graph to Your Preference

After you have set up your measurement, you may wish to adjust the graph x-axis or move markers.

Adjust the X-Axis

You can adjust the x-axis in any of the following ways:

- Click  and enter graph limits as start/stop or center/span.

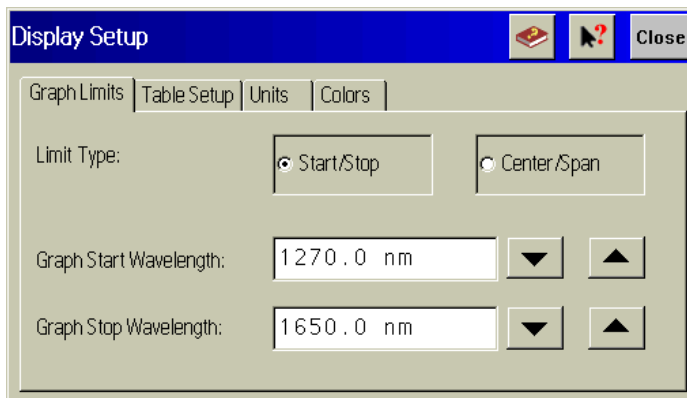

- Select an x-axis control from the Graph Control list. Click anywhere on the graph and drag to the left or right.

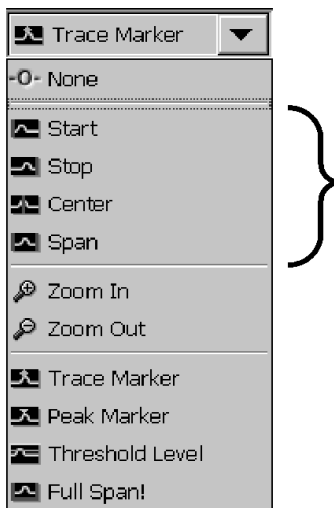

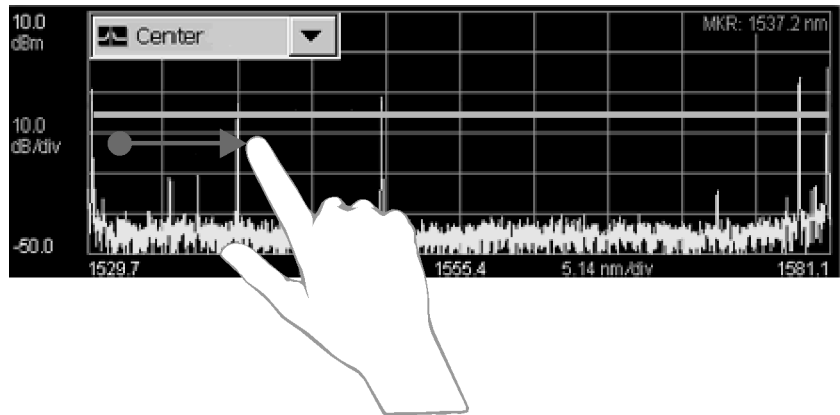

Move the Peak Marker

You can move the peak marker in any of the following ways:

- Click any cell in the “Peak” column of the table. The peak marker will move to the corresponding peak wavelength in the graph.

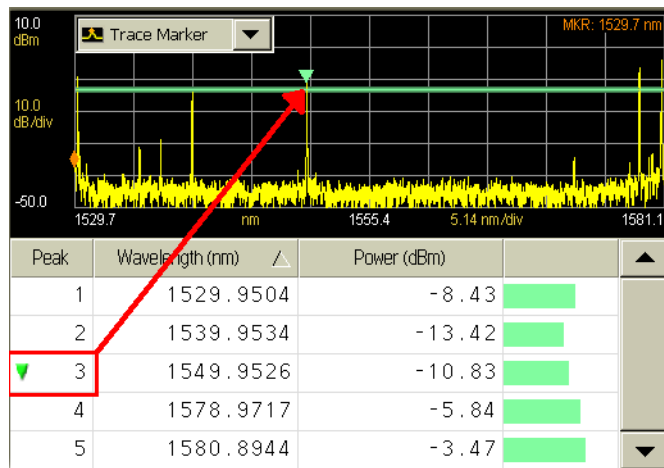

- If ClickZoom is enabled, click any cell in the “Wavelength” column of the table. The peak marker will move to the corresponding peak wavelength in the graph, and the graph will zoom in to that peak. To zoom out, click the “Wavelength” cell again.

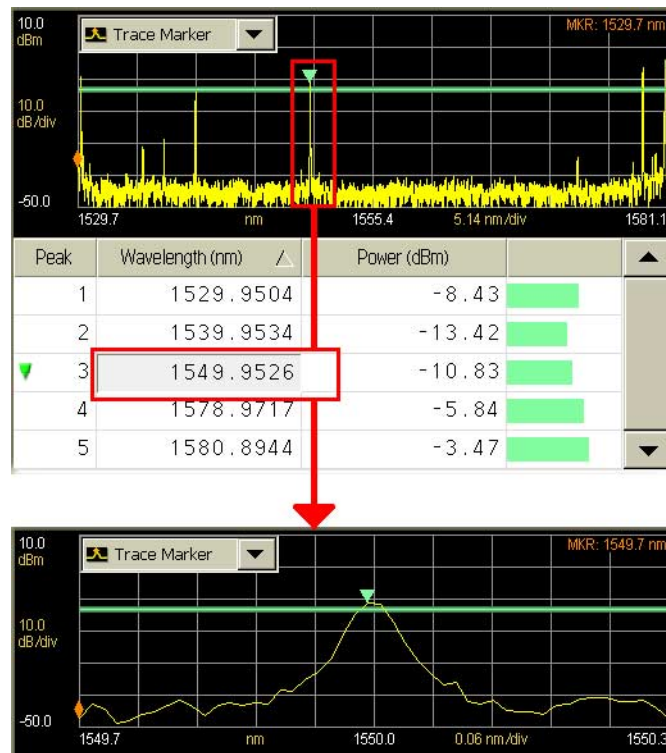

- Select Peak Marker from the Graph Control list. Click close to a peak on the graph.
- Select Peak Marker from the Graph Control list. Click anywhere on the graph and drag to the left or right.

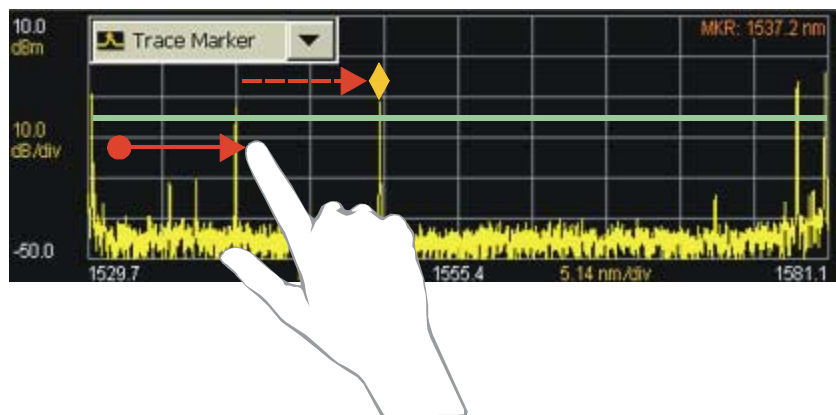

- Select Peak Marker from the Graph Control list. Click close to a peak on the graph.
- Select Peak Marker from the Graph Control list. Click anywhere on the graph and drag to the left or right.

Move the Trace Marker

You can move the trace marker in any of the following ways:

- Select Trace Marker from the Graph Control list. Click any point on the graph.
- Select Trace Marker from the Graph Control list. Click anywhere on the graph and drag to the left or right.

Step 6. Save Measurement Results

After you have set up your measurement and the graphical display, you may wish to save measurement results.

Save Data

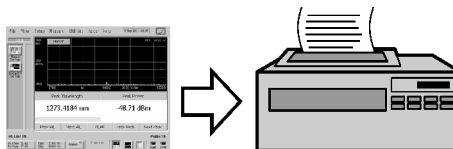

Press  to open the Save Meas Data dialog box. Select a file name and click **Save**.

Print Data

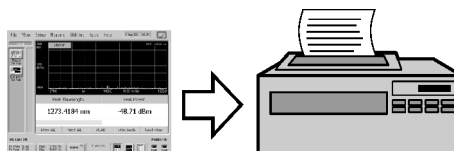

Press  to open the Print Setup dialog box. Select the Default Printer and Printout Type, and click Print.

Save Screen Image

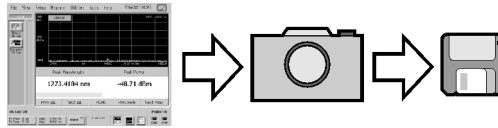

On the File menu, point to Save, and then click Save Screen Image. Select a file name and click Save

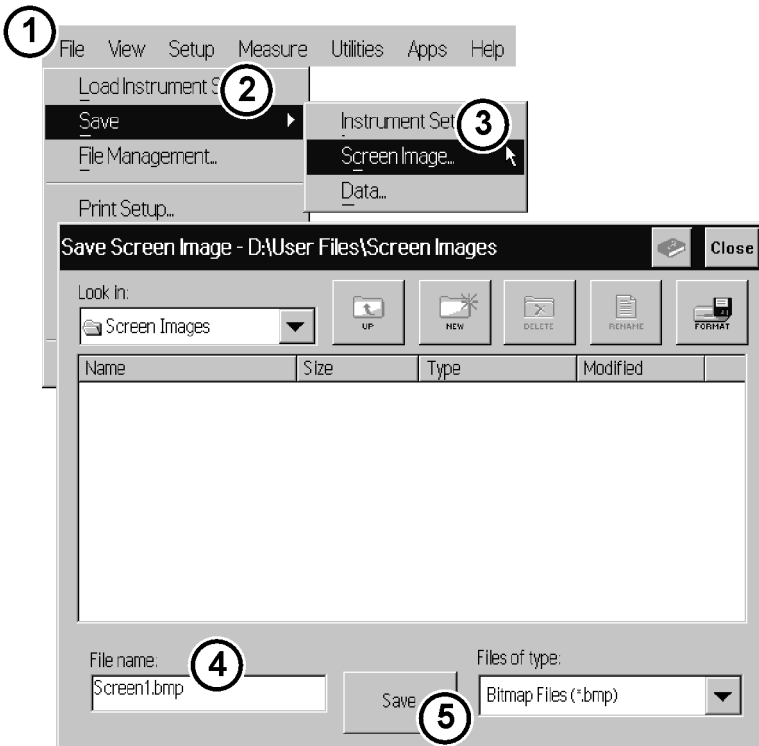

Data Logging

Data logging allows you to record measurement data over time for later analysis. Follow the steps below to set up data logging.

- 1 On the Measure menu, click Data Logging.
- 2 Enter the Logging Duration and Logging Interval time.
- 3 Click Start Data Logging.

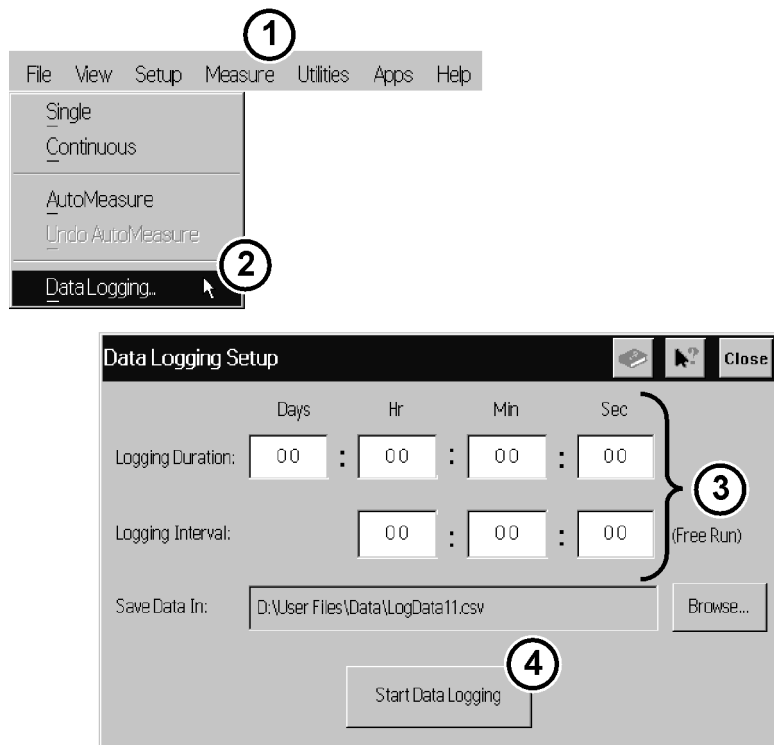

Consider the following example applications:

- To log data for a long-term stability/drift test, set the data logging duration to 24-hrs, and the interval to 5 minutes.
- To log data for a turn-on transient test (to observe how lasers change during warm-up), set the data logging duration to 5 minutes, and the interval to 0 time (free run).



4

Using the Built-In Information System

Introduction.....	94
The 86122A Help Contents.....	95
Description of the Contents Topics.....	96
Getting Help While Changing Instrument Settings.....	98
Hiding the Help.....	99
Printing the Contents of a Topic.....	100
Selecting the Help Language.....	101

Introduction

The 86122A contains a built-in information system—it is referred to as Help. The Help contains the information that would traditionally be in the user’s and programmer’s guide.

To access the Help, simply click Contents on the Help menu. This will display the contents topic that is shown in the figure on the following page. Navigating through the Help should be familiar to you because it is similar to other Windows applications. You can, of course, navigate through the help by either using the touch screen or the mouse.

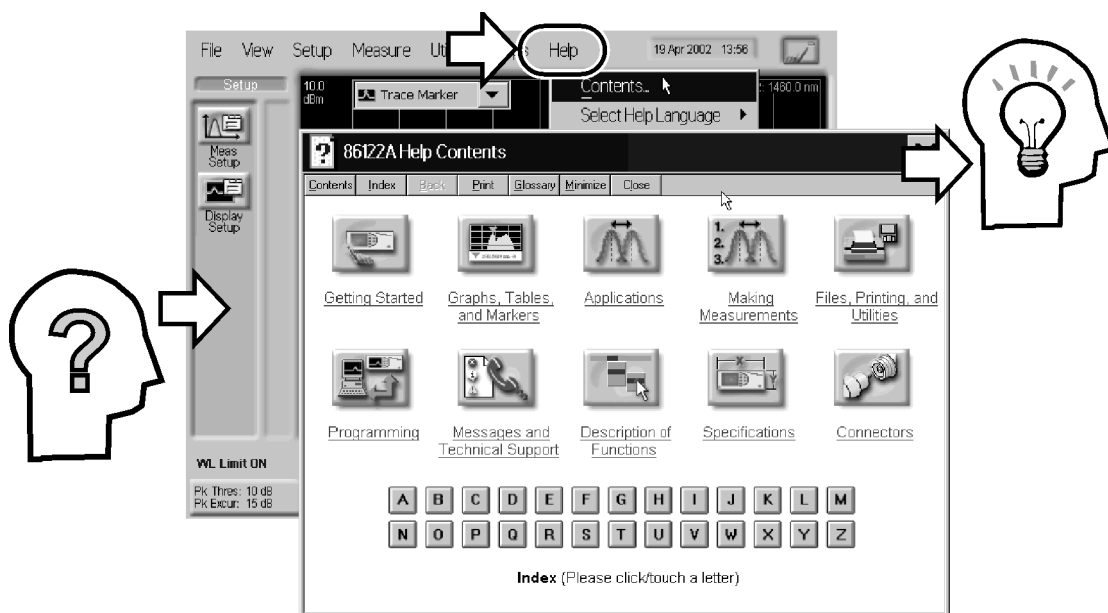

In this chapter, you’ll learn features that are unique to the 86122A Help, as well as tips that will make the Help more useful to you.

The 86122A Help Contents

The following figure shows the 86122A Help contents. This is the starting point for learning how to use your Agilent Variable Optical Attenuator modules and Agilent Variable Optical Attenuator modules with Power Control.

In addition to the 10 topics presented in the contents, be sure to use the index buttons located along the bottom. These can be very helpful in locating a topic of interest.

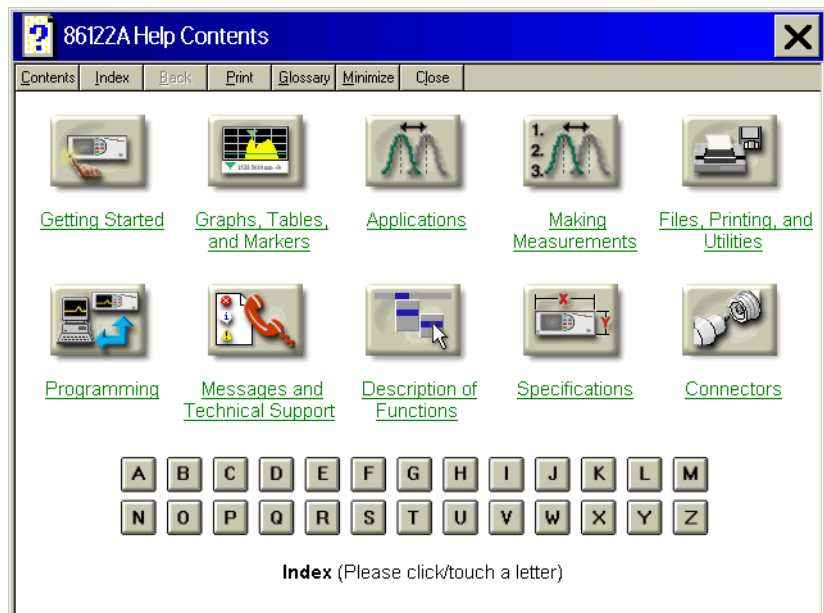

Description of the Contents Topics

The following list describes the information you can find in each of the contents topics.

Table 8









 <p>Getting Started</p>	<p>This topic contains links to useful information you may want to read first.</p>
 <p>Graphs, Tables, and Markers</p>	<p>This topic explains how to use graphs, tables, and markers.</p>
 <p>Applications</p>	<p>This topic provides information about the available measurement applications.</p>
 <p>Making Measurements</p>	<p>This topics explains the steps required to make a measurement.</p>
 <p>Files, Printing, and Utilities</p>	<p>This topic contains descriptions of all file, printing, and utility functions.</p>
 <p>Programming</p>	<p>This topic provides information about programming the instrument, programming examples, and all valid programming commands.</p>

Table 8

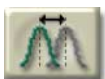
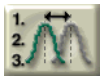
 <p>Messages and Technical Support</p>	<p>This topic provides information about instrument messages and errors, and technical support information.</p>
 <p>Description of Functions</p>	<p>This topic contains descriptions of all instrument functions.</p>
 <p>Specifications</p>	<p>This topic lists specifications and characteristics for the instrument.</p>
 <p>Connectors</p>	<p>This topic provides information about optical connector care</p>

Getting Help While Changing Instrument Settings

Help is available directly from dialog boxes whenever you change any settings for the instrument. For example, consider the task of changing the time and date used by the Agilent Variable Optical Attenuator modules and Agilent Variable Optical Attenuator modules with Power Control. When changing the settings, as shown in the following figure, click the Book icon to learn general information. Or, click the What's this? icon to find more specific information about an item. After clicking the What's this? icon, keep your finger on the display and "drag" the ? to the button or field in which you are interested. When you release your finger, a description appears as shown in the following figure.

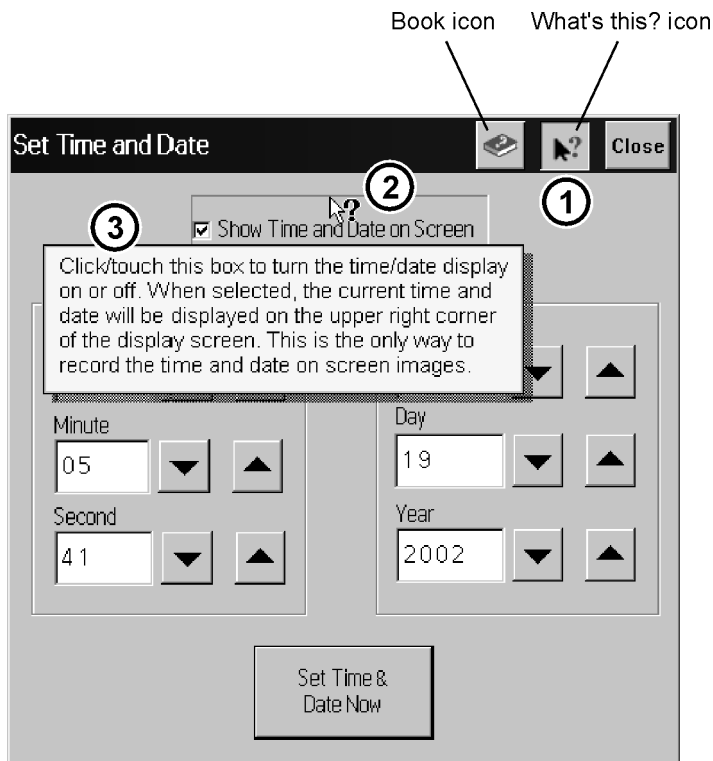

Hiding the Help

When using the Help, you can temporarily hide it so that you can see the entire display. You can then re-display the Help with the same topic still showing.

- To hide the Help, click the Minimize button located at the top of the Help window.

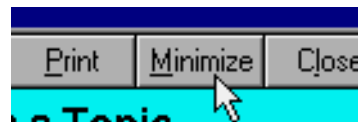

- To re-display the Help, click the Restore button that is shown on the display.



Printing the Contents of a Topic

You can print the entire contents of a Help topic by clicking the Print button located at the top of the Help window.

You can print the entire contents of a pop-up Help window, by following the steps below.

- 1 Connect a printer and a mouse pointing device to the Agilent Variable Optical Attenuator modules and Agilent Variable Optical Attenuator modules with Power Control.
- 2 Place the pointer over the topic, and click the right button. Then click on Print Topic.

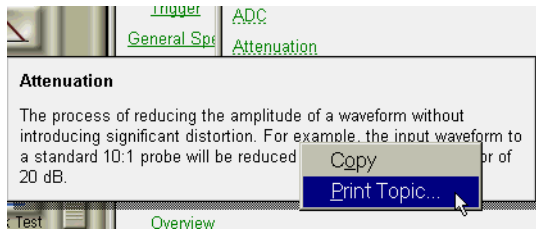

Selecting the Help Language

Future versions of Help may be available in more than one language. On the Help menu, click **Select Help Language**, and then click the language you want to view. Please ensure that the Help file is closed before changing the language selection. You can only view one version of help at a time.

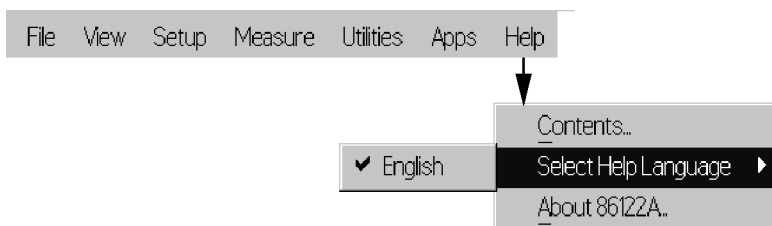

Help Version

Refer to the English version of help to view the most current information about instrument features and specifications.



5

Specifications and Regulatory Information

Specifications	104
Compliance with German Noise Requirements	108
Compliance with Canadian EMC Requirements	108
Declaration of Conformity.....	109

Specifications

Table 9

Description	86122A	Notes
Wavelength		
Range	1270-1650 nm (182-236 THz)	
Absolute Accuracy	±0.2 ppm	
at 1550 nm	±0.3 pm	
at 1310 nm	±0.3 pm	
for laser lines separated by	≥10 GHz	
Differential Accuracy ^[1]	±0.15 ppm	
Minimum Resolvable Separation ^[1] (equal power lines input)	5 GHz	For lines separated by less than the specified amount, wavelength accuracy is reduced.
at 1550 nm	0.04 nm	
at 1310 nm	0.03 nm	
for laser lines separated by	≥10 GHz	
Display Resolution	0.0001 nm	
Fast update mode	N/A	
Units	nm (vacuum or standard air), cm ⁻¹ , THz	
Power		
Calibration Accuracy	±0.5 dB (at ±30 nm from 1310 and 1550 nm)	
Flatness ^[1]	±0.2 dB (1270 to 1600 nm) ±0.5 dB (1270 to 1650 nm)	30 nm from any wavelength
Linearity	±0.3 dB (1270 to 1600 nm)	Lines above -30 dBm
Polarization Dependence	±0.5 dB (1270 to 1600 nm) ±1.0 dB ^[1] (1600 to 1650 nm)	
Display Resolution	0.01 dB	
Units	dBm, mW, μW	
Sensitivity ^[2]		
Single Line Input	-32 dBm (1270 to 1600 nm) -22 dBm (1600 to 1650 nm)	
Multiple Lines Input ^[1]	25 dB below total input power, but not less than single line input sensitivity	

Table 9

Description	86122A	Notes
Selectivity ^[1]	25 dB spacing \geq 90 GHz 10 dB spacing \geq 10 GHz	
Input Power		
Maximum Displayed Level Maximum Safe Input Level	+10 dBm +18 dBm	Sum of all lines input
Return Loss With Straight Connectors (PC, Opt. 021) With Angled Connectors (APC, Opt. 022)	35 dB 50 dB	
Measurement Cycle Time	0.5 s	
Maximum Number of Lines	1000	Number of laser lines may be limited by signal power requirements for accurate wavelength measurements.
Measurement Modes	List by wavelength table, list by power table, peak wavelength and power, average wavelength and total power	Data Logging and sorting by any parameter are included in the 86122A.
Delta Modes	Delta wavelength, delta power, delta wavelength and power	
Built in Automatic Measurement Applications		
Signal to Noise Ratio ^{[1][4]} Channel Spacing \geq 100 GHz Channel Spacing \geq 50 GHz	>35 dB with 100 averages >27 dB with 100 averages	0.1 nm noise bandwidth. Lines above -25 dBm.
Drift	Maximum, minimum, total drift (max-min) of wavelengths and powers over time	
Fabry-Perot Characterization	Mean wavelength, peak wavelength, mode spacing full-width half maximum, peak amplitude total power, sigma	
Additional Features	Power offset, power bars (on or off), user adjustable peak excursion and peak threshold, user adjustable start and stop wavelength limits, graphical display, save and recall instrument states.	
Inputs/Outputs		
Optical Input	9/125 μ m single-mode fiber	
Rear Panel Connectors	LAN, PS/2 for Keyboard & Mouse, SVGA for external monitor, GPIB, parallel printer port, AC Line, optional optical input	

Table 9

Description	86122A	Notes
Dimensions and Weight		
Dimensions	138 mm x 425 mm x 520 mm (H x W x D) (5.2 in x 16.7 in x 20.5 in)	
Weight	14.5 kg (32 lb)	
Environmental		
Operational Temperature Humidity ^[3]	+15°C to +35°C <75% R.H. at +35°C	
Shock ^[3]	120 g	Half sine, 2 msec pulse
Vibration ^[3]	2 g rms 0.5 g (0 to peak)	Random, 5 to 500 Hz, 10 min./axis Sine, 5 to 500 Hz, 1 octave/min.
EMC	Conducted and radiated interference is in compliance with CISPR Pub 11, IEC 801-2, IEC 801-3, IEC 801-4 and IEC 555-2	
Storage Temperature Humidity ^[3]	-40°C to +70°C 95% R.H. at +40°C, 5 day cycle	Noncondensing
Power Requirements		
Voltage and frequency	90 to 264 VAC, 47 Hz to 63 Hz	
Maximum Power	310 VA max	

¹ Characteristic

² Contact Agilent Technologies for availability of special instruments with higher sensitivity.

³ Type tested means tested, but not warranted, for continuous operation.

⁴ At 1550 nm

Laser Safety Information

The light sources specified by this user guide are classified according to IEC 60825-1 (2001).

The light sources comply with 21 CFR 1040.10 except for deviations pursuant to Laser Notice No. 50, dated 2001-July-26

Table 10

Laser type	LED
Wavelength	1270-1650 nm
Max. CW output power *	1 nW
Beam waist diameter	10 μm
Numerical aperture	0.1
Laser class according to IEC 60825-1 (2001)	1
Max. permissible CW output power **	10 mW
* Max. CW output power means the highest possible optical CW power that the laser source can produce at its output	
** Max. permissible CW output power is the highest optical power that is permitted within the appropriate IEC laser class.	

WARNING

WARNING - Please pay attention to the following laser safety warnings:

- Under no circumstances look into the end of an optical cable attached to the optical output when the operational. The laser radiation can seriously damage your eyesight.
- Do not enable the laser when there is no fiber attached to the optical output connector.
- Pressing the "active" button enables the laser. The laser is on when the green-LED is lit.
- The use of optical instruments with this product will increase eye hazard.
- Refer servicing only to qualified and authorized personnel.

Compliance with German Noise Requirements

This is to declare that this instrument is in conformance with the German Regulation on Noise Declaration for Machines (Laermangabe nach der Maschinenlaermrerordnung -3.GSGV Deutschland).

Table 11 Notice for Germany: Noise Declaration

Acoustic Noise Emission	Geräuschemission
LpA < 70 dB	LpA < 70 dB
Operator position	am Arbeitsplatz
Normal position	normaler Betrieb
per ISO 7779	nach DIN 45635-1 t.19

Compliance with Canadian EMC Requirements

This ISM device complies with Canadian ICES-001.

Cet appareil ISM est conforme a la norme NMB-001 du Canada.

Declaration of Conformity



Manufacturer's Name: Agilent Technologies International sarl
Manufacturer's Address: Rue de la Gare 29
 CH-1110 Morges
 Switzerland

Declares under sole responsibility that the product as originally delivered

Product Name: Multi Wavelength Meter
Product Number: 86122A
Product Options: *This declaration covers all options of the above products.*

complies with the essential requirements of the following applicable European Directives, and carries the CE marking accordingly:

- The Low Voltage Directive 73/23/EEC, amended by 93/68/EEC
- The EMC Directive 89/336/EEC, amended by 93/68/EEC

and conforms with the following product standards:

	Standard	Limit
EMC	IEC 61326:1997+A1:1998+A2:2000 / EN 61326:1997+A1:1998+A2:2001 CISPR 11:1997+A1:1999 / EN 55011:1998+A1:1999 IEC 61000-4-2:2001 / EN 61000-4-2:1995+A1:1998+A2:2001 IEC 61000-4-3:2002 / EN 61000-4-3:2002 IEC 61000-4-4:2001 / EN 61000-4-4:1995+A1:2001+A2:2001 IEC 61000-4-5:2001 / EN 61000-4-5:1995+A1:2001 IEC 61000-4-6:1995+A1:2000 / EN 61000-4-6:1996+A1:2001 IEC 61000-4-8:2001 / EN 61000-4-8:1993+A1:2001 IEC 61000-4-11:1994+A1:2000 / EN 61000-4-11:1994+A1:2001 Canada: ICES-001:1998 Australia/New Zealand: AS/NZS 2064.1	Group 1 Class A 4kV CD, 8kV AD 3 V/m, 80-1000 MHz 0.5kV signal lines, 1kV power lines 0.5 kV line-line, 1 kV line-ground 3V, 0.15-80 MHz 30 A/m 1 cycle/100%
Safety	IEC 61010-1:2001 / EN 61010-1:2001 IEC 60825-1:2001 / EN 60825-1:1994+A11:1996+A2:2001 Canada: CAN/CSA-C22.2 No. 61010-1:2004 USA: UL 61010-1:2004	

Supplementary Information:

The products were tested in a typical configuration with Agilent Technologies test systems.
 FDA accession number:

This DoC applies to above-listed products placed on the EU market after:

2004-Oktober-01
 Date

 Hans-Martin Fischer
 Name

Product Regulations Representative PMD, DVS
 Agilent Technologies
 Title

For further information, please contact your local Agilent Technologies sales office, agent or distributor.

Agilent Technologies GmbH 2004

Printed in Germany November 2004
Second edition, November 2004



86122-90004